

~~TM 9-617~~

WAR DEPARTMENT TECHNICAL MANUAL

~~RESCINDED~~ Per DA Circular 310-39 FEB 24 1961

Generating Unit M18

Generating Unit M18



0-190583
PROPERTY OF U.S.

WAR DEPARTMENT
Washington 25, D. C., 19 January 1944

TM 9-617, Generating Unit M18, is published for the information and guidance of all concerned.

[A.G. 300.7 (19 Jan 44)
O.O. 300.7/1021 (20 Jan 44)]

BY ORDER OF THE SECRETARY OF WAR:

G. C. MARSHALL,
Chief of Staff.

OFFICIAL:

J. A. ULIO,
Major General,
The Adjutant General.

DISTRIBUTION: R 9 (4); Bn and H 44 (3); Bn 9 (2); C 9 (5);
IC 44 (5).

(For explanation of symbols, see FM 21-6.)

CONTENTS

PART ONE — OPERATING INSTRUCTIONS

SECTION		Paragraphs	Pages
I.	Introduction	1- 3	4- 11
II.	Operation and controls	4- 9	11- 20
III.	Inspection	10- 15	21- 24
IV.	Lubrication	16- 18	25- 27
V.	Tools and equipment	19- 22	28- 30
VI.	Operation under unusual conditions	23- 34	30- 40

PART TWO — ORGANIZATIONAL MAINTENANCE INSTRUCTIONS

SECTION VII.	Trouble shooting	35- 44	41- 48
VIII.	Frame	45- 46	48- 49
IX.	Engine	47- 49	49- 55
X.	Cooling system	50- 56	55- 64
XI.	Exhaust system	57- 61	65- 71
XII.	Fuel system	62- 68	71- 82
XIII.	Engine lubrication system ..	69- 72	83- 87
XIV.	Engine electrical system ...	73- 79	87-109
XV.	Generating system	80- 84	110-115
XVI.	Instrument panel and instru- ments	85-106	116-127
XVII.	Painting	107-112	127-129
XVIII.	Storage and shipment	113-115	130-135
XIX.	References	116-118	135-136
INDEX		137-141

GENERATING UNIT M18

PART ONE

OPERATING INSTRUCTIONS

Section I

INTRODUCTION

	Paragraph
Scope	1
Characteristics	2
Data	3

1. SCOPE.*

a. This manual is published for the information of the using arms and services.

b. In addition to a description of the Generating Unit M18, this manual contains technical information required for the identification, use, and care of the materiel.

c. Disassembly, assembly, and such repairs as may be handled by using arm personnel may be undertaken only under the supervision of an officer or of the chief mechanic.

d. In all cases where the nature of the repair, modification, or adjustment is beyond the scope or facilities of the unit, the responsible ordnance service should be informed so that trained personnel with suitable tools and equipment may be provided, or proper instructions issued.

2. CHARACTERISTICS.

a. The Generating Unit M18 (figs. 1 and 2) is a gasoline engine actuated generator mounted on a specially designed rubber-tired trailer or on wood skids. The frame is of welded structural steel construction. It is bolted to the floor of the trailer. The engine and generator assembly is enclosed by a sheet metal canopy bolted to a base frame. Side doors give access to the instrument panel, engine, generator, and other parts within the canopy.

b. A 10-gage, sheet-steel instrument and control panel is located over the generator on the left-hand side of the unit.

c. The Generator Trailer M7, illustrated in figures 3 and 4, is designed primarily for travel on highways, and to afford a solid operating foundation for the generating unit. Four built-in corner lift jacks (fig. 4) give firm ground contact, and lift the weight off springs and tires.

*To provide operating instructions with the materiel, this Technical Manual has been published in advance of complete technical review. Any errors or omissions will be corrected by changes or, if extensive, by an early revision.

INTRODUCTION

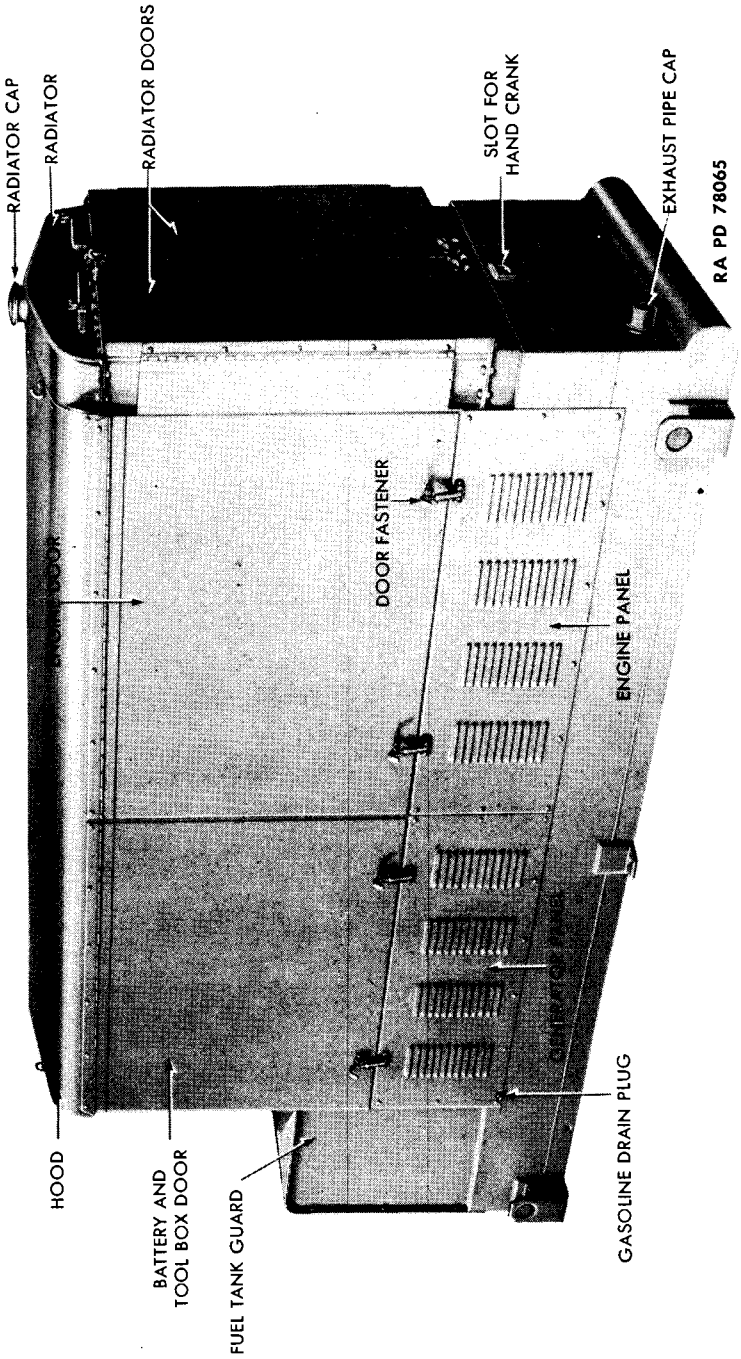

Figure 1 — Generating Unit M18 — Right Front

GENERATING UNIT M18

RA PD 78103

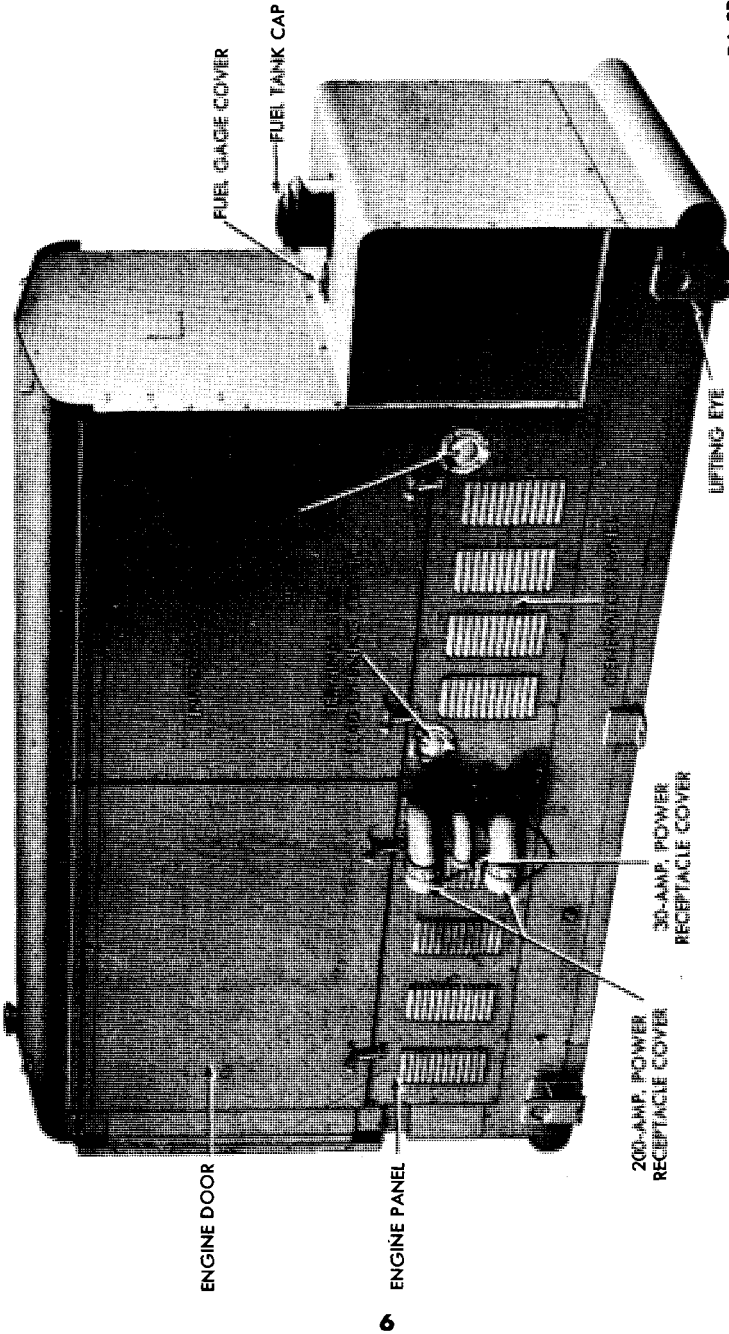
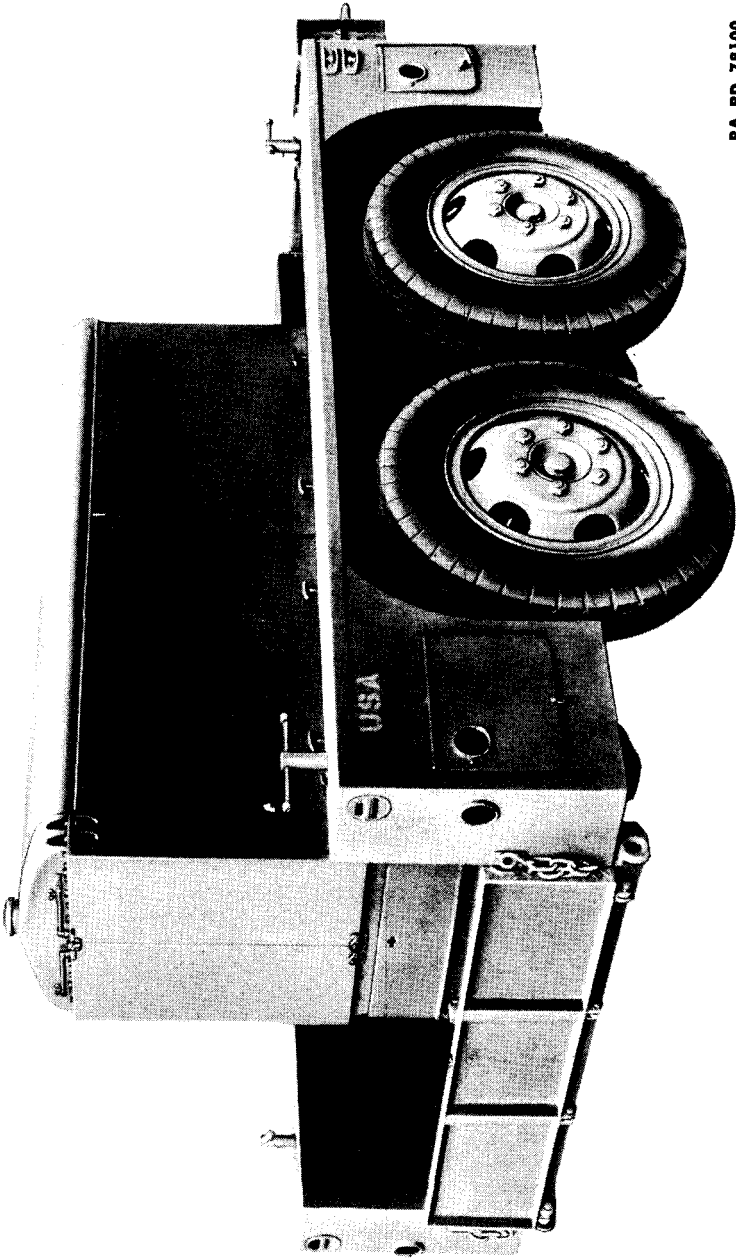

Figure 2 — Generating Unit M18 — Left Rear

INTRODUCTION



RA PD 78100

Figure 3 — Generating Unit M18 and Generator Trailer M7 — Ready to be Moved

GENERATING UNIT M18

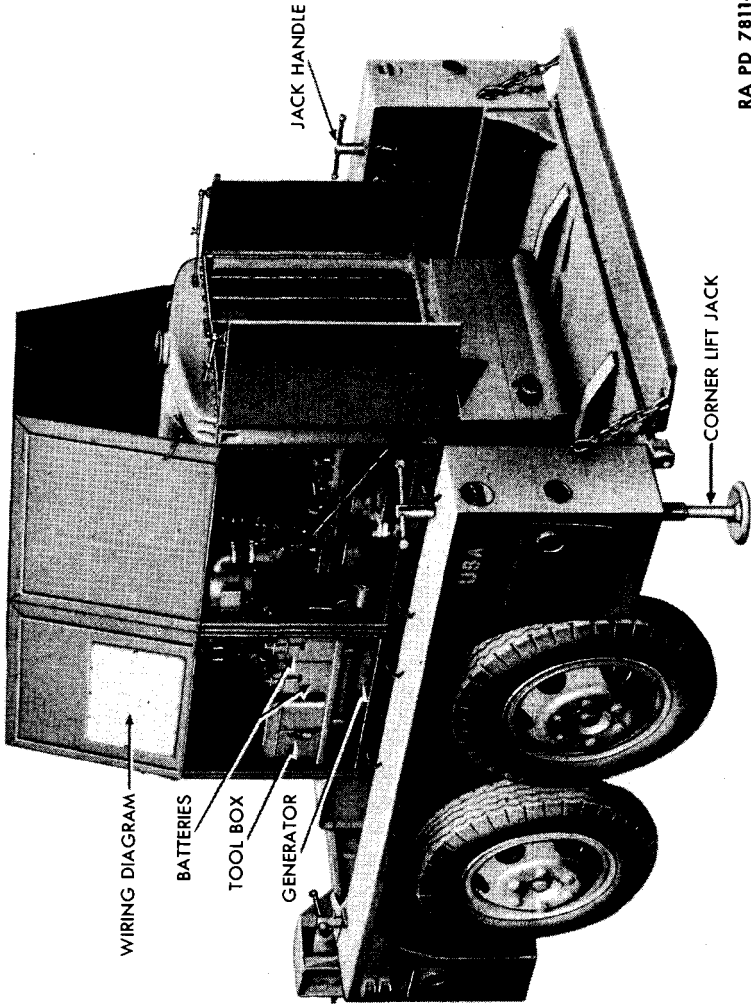

RA PD 78114

Figure 4 — Generating Unit M18 and Generator Trailer M7 — All Doors Open

INTRODUCTION

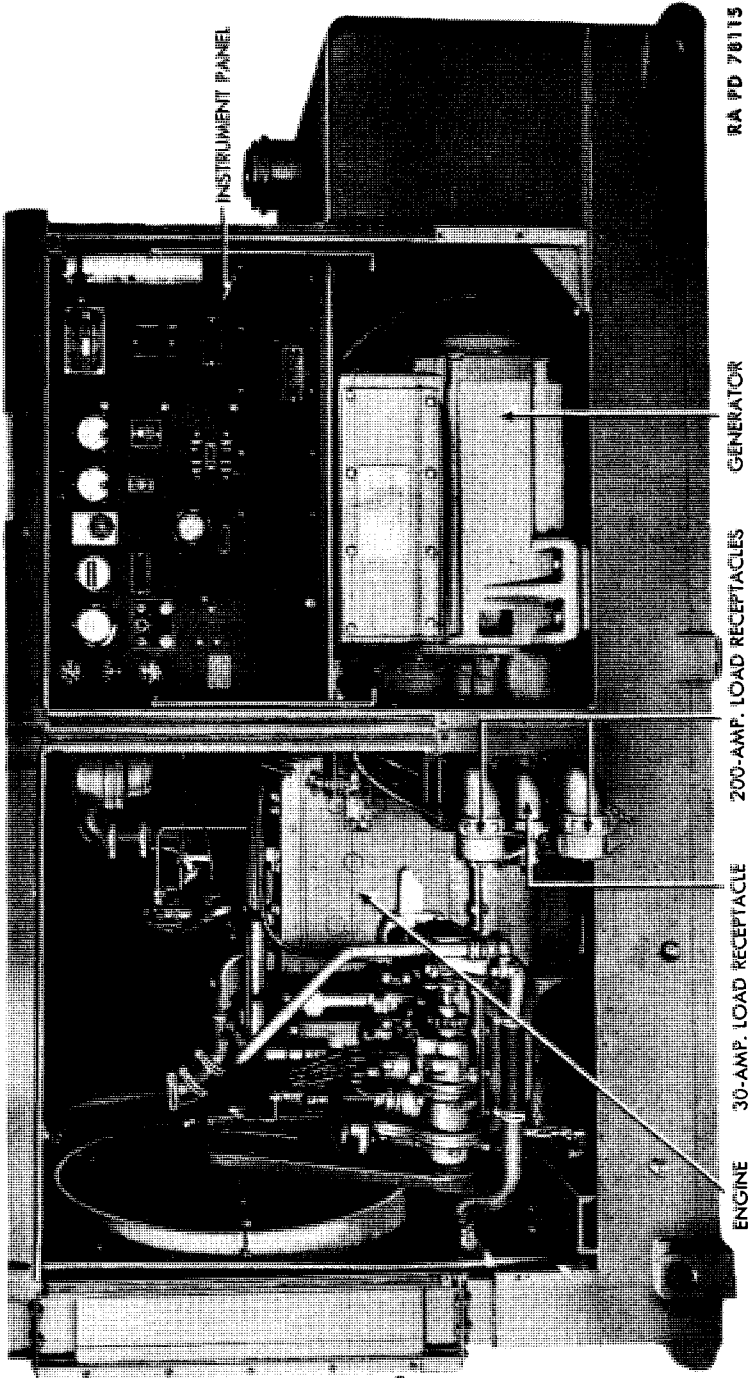

RA PD 78115

GENERATOR

200-AMP. LOAD RECEPTACLES

30-AMP. LOAD RECEPTACLE

ENGINE

Figure 5 — Generating Unit M18 — Doors Open and Panels Removed — Left Side

GENERATING UNIT M18

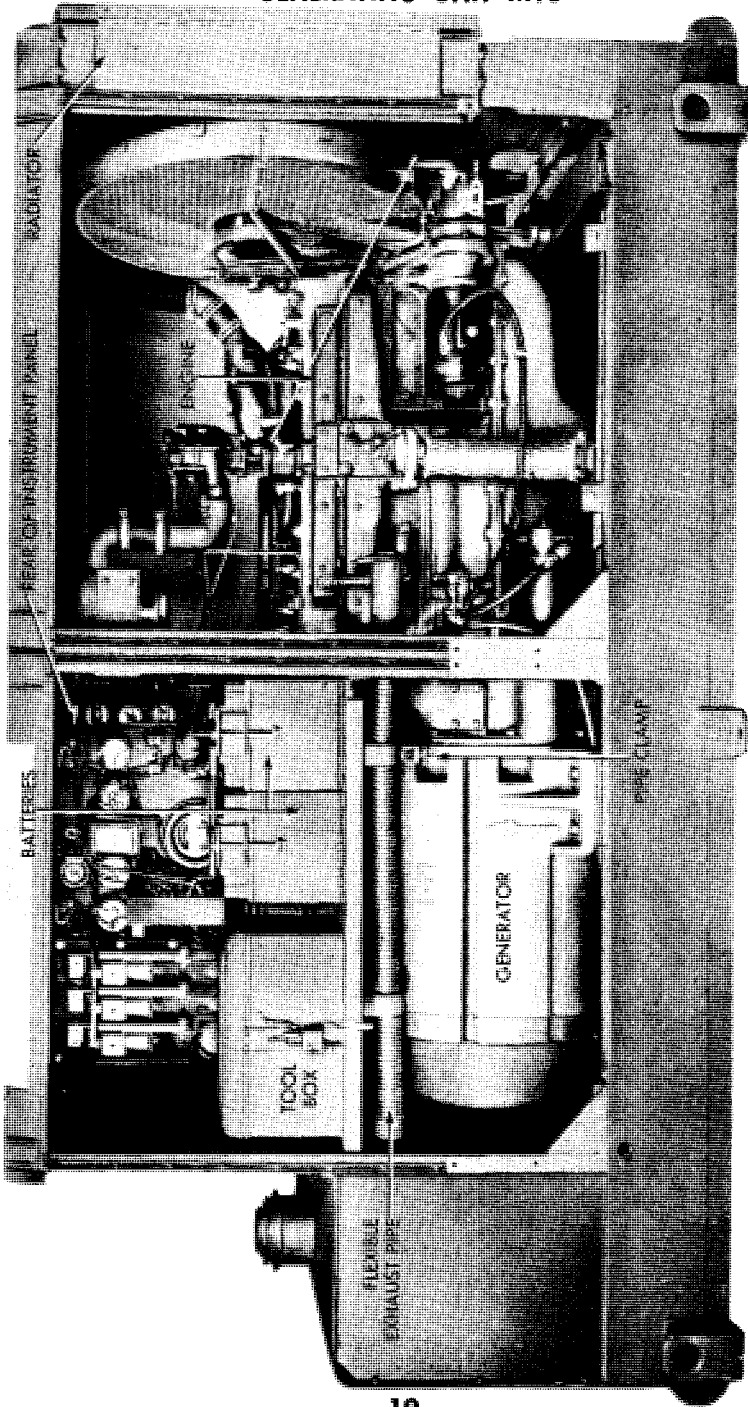

RA PD 78097

Figure 6 — Generating Unit M18 — Doors Open and Panels Removed — Right Side

OPERATION AND CONTROLS

The trailer can be coupled to any vehicle equipped with a pintle hook. Brakes and lights operate electrically from any vehicle having a suitable outlet and controller. A retractable parking wheel supports the drawbar when the trailer is uncoupled. For generator trailer operating instructions, see TM 9-881.

d. Some Generating Units M18 are mounted on Generator Skids M1 instead of on the trailer. The skids are 3-inch by 6-inch oak runners, bolted to the under side of the generator platform. They facilitate handling of the unit in loading and unloading from the truck on which it is carried.

3. DATA.

Length, over-all	100½ in.
Width, over-all	41⅝ in.
Height, over-all	56⅝ in.
Weight, less fuel and water	4,194 lb
Fuel capacity	25 gal
Cooling system capacity	36 qt
Crankcase capacity	7 qt
Rated generator output	30-kw (80 percent power factor), 3-phase, 60-cycle, 125-v or 30-kw (80 percent power factor), 3-phase, 60-cycle, 250-v

Section II

OPERATION AND CONTROLS

	Paragraph
Preparing for first operation of generating unit	4
Engine and generator controls	5
Starting the unit	6
Operating the unit	7
Stopping the unit	8
General care and precautions	9

4. PREPARING FOR FIRST OPERATION OF GENERATING UNIT.

a. Batteries.

(1) The batteries are shipped dry, with the plates in a charged condition. Vent plugs are screwtight with sealing disks, and must remain so until the cells are filled with electrolyte. Store in a cool dry place, away from direct sunlight, radiation, or heating devices.

(2) Before using, the batteries must be filled with electrolyte, and given a freshening charge by ordnance personnel.

GENERATING UNIT M18

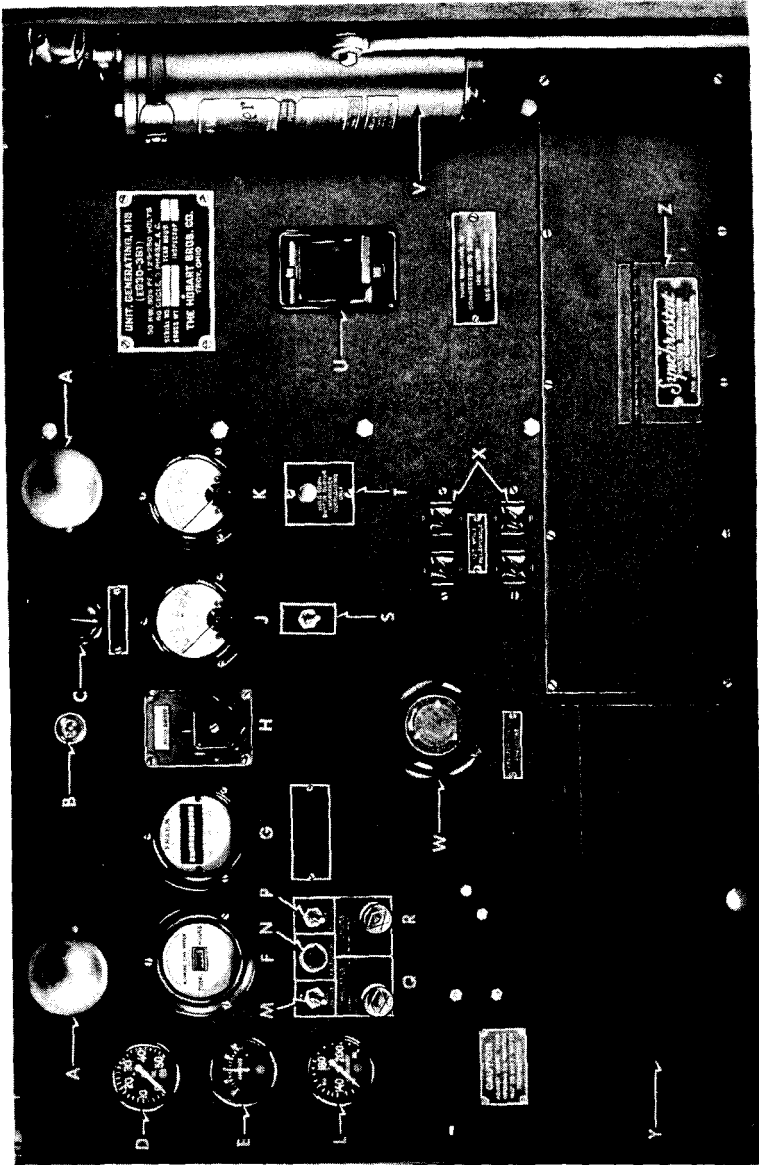

RA PD 78105

Figure 7 — Instrument Panel

OPERATION AND CONTROLS

- | | |
|----------------------------|-----------------------------|
| A—125-VOLT LAMP | N—6-VOLT RECEPTACLE |
| B—6-VOLT LAMP | P—6-VOLT LIGHT SWITCH |
| C—LAMP DIMMING RHEOSTAT | Q—THROTTLE |
| D—OIL PRESSURE GAGE | R—CHOKE |
| E—BATTERY CHARGING AMMETER | S—125-VOLT LIGHT SWITCH |
| F—RUNNING TIME METER | T—EMERGENCY OVERLOAD SWITCH |
| G—FREQUENCY METER | U—CIRCUIT BREAKER |
| H—METER SWITCH | V—FIRE EXTINGUISHER |
| J—VOLTMETER | W—FIELD RHEOSTAT |
| K—AMMETER | X—125-VOLT RECEPTACLES |
| L—TEMPERATURE GAGE | Y—LOAD TERMINAL BOX COVER |
| M—IGNITION SWITCH | Z—VOLTAGE REGULATOR COVER |

RA PD 78105A

Legend for Figure 7 -- Instrument Panel

GENERATING UNIT M18

b. Lubricating Oil.

(1) Fill the engine crankcase oil pan (through the filler pipe) to the proper level, as indicated by the "4/4" mark on the bayonet-type level gage (fig. 10). Since allowance must be made for the oil filter capacity, it will be necessary to run the engine a few minutes, recheck the level, and add oil to the "4/4" mark.

(2) Use the grade of engine oil specified in lubrication guide (fig. 11), or for temperatures below zero degree F, in paragraph 25.

c. Cooling Water.

(1) Fill the radiator with 36 quarts of clear water, using the softest available. Be sure the cooling system drain valve is closed.

(2) For operation below 32 F, the following mixture should be added to the radiator: To 10 parts by volume of water, add the following parts by volume of COMPOUND, antifreeze, after draining off an appropriate quantity of water:

Temperature (Degrees F)	Water (Parts by Volume)	COMPOUND, Antifreeze (Parts by Volume)
+20	10	2
+10	10	3 1/3
0	10	5
-15	10	7 1/4
-30	10	10
-40	10	12

NOTE: Immediately start the engine, and run at idling speed without load until warm, to mix thoroughly the antifreeze and water solution.

d. Fuel. Fill the fuel tank with 25 gallons of gasoline. Fuel consumption (72 octane fuel) will be at the rate of approximately 1 gallon per 6 kilowatt hours at rated load of 30 kilowatts. When using 80 octane fuel, the output of the generating unit is approximately 10 percent higher than when using 72 octane fuel.

5. ENGINE AND GENERATOR CONTROLS (fig. 7).

a. Choke. The use of the choke, located at lower right in the control group on the left-hand side of the instrument panel, depends mainly on the climate in which the unit is operating. In cold climates, it should be pulled all the way out, and kept in this position for the first few revolutions of the engine crankshaft. In warm climates, this is seldom necessary. The choke should always be used as sparingly as possible.

b. Throttle. The throttle is at the lower left in the control group on the left-hand side of the instrument panel. Its use is normally confined to the starting and stopping of the engine. The engine is started with the throttle all the way in. As soon as the engine begins to fire, the throttle is pulled out quickly, until the speed is approximately 600 revolutions per minute. As the engine warms up sufficiently for full speed operation, the throttle is gradually pushed in. *When stopping*

OPERATION AND CONTROLS

the engine, the throttle is pulled to full out position, and the engine allowed to idle for a minute before the ignition is turned off; otherwise, backfire might damage muffler.

c. Doors. While the unit is running, both radiator doors are usually fastened open. For quick warming up in cold weather, the doors may be kept closed until the desired engine temperature is obtained. While the unit is running, the instrument panel door is open and fastened back with the chain provided, or with door props during rainy weather. Other canopy doors are kept closed, unless their use is required to help adjust the temperature.

d. Field Rheostat. The field rheostat, located on the lower left center of the instrument panel, controls the output voltage of the generating unit when the voltage regulator switch is in "OFF" position (fig. 69). Turning the knob clockwise increases the voltage delivered. When operating the generating unit with the voltage regulator switch in "ON" position, rheostat handwheel must be turned all the way to the right, or in clockwise direction.

e. Ignition Switch. The ignition switch, which controls the 12-volt ignition system, is at the upper left in the control group on the left side of the instrument panel.

f. Start Switch. The starting, or cranking switch is adjacent to the lower corner of the instrument panel. It can be reached through the left-hand engine door (fig. 14).

g. Meter Switch. The meter switch used to check amperage and voltage is at upper center of the instrument panel.

h. Voltmeter. The voltmeter is centrally located on the instrument panel, at the right of the meter switch. This instrument indicates the voltage of the current generated, normally 125 volts or 250 volts.

i. Ammeter. The ammeter is centrally located on the instrument panel, to the right of the voltmeter. This ammeter, in conjunction with the meter switch, indicates the amperage of current being delivered.

j. Circuit Breaker. The switch, which starts and stops the delivery of power to the load, is on the right-hand side of the instrument panel, directly below the unit name plate.

k. Temperature Gage. The engine temperature gage is at the lower left-hand side of the instrument panel. The engine running temperature should be between 160 F and 180 F.

l. Oil Pressure Gage. The oil pressure gage is at the extreme top left of the instrument panel. The pressure should be approximately 25 pounds at 1,200 revolutions per minute, with the engine running at normal operating temperature.

m. Battery-charging Ammeter. The battery-charging ammeter is located in the upper left-hand corner of the instrument panel below the oil pressure gage.

GENERATING UNIT M18

n. Fuel Gage. A mechanical-type fuel gage set into the tank is used. It is located adjacent to the filler neck on top of the fuel tank.

o. Lamp-dimming Rheostat. The lamp-dimming rheostat, used to dim the 125-volt lamps, is located at the top center of the panel.

p. Frequency Meter. A vibrating reed-type frequency meter is used in place of a tachometer to determine engine speed and a-c frequency output. It is located at top center of the instrument panel to the left of the meter switch.

q. Running Time Meter. A nonadjustable running time meter is located on the panel to the left of the frequency meter. It registers the cumulative total of hours the unit is in operation to the nearest tenth hour. It registers up to 9,999.9 hours and then repeats.

r. 6-volt Receptacle. Located on the panel, to the right of the ignition switch, is a 6-volt, single contact receptacle. Its purpose is to accommodate the 6-volt trouble light.

s. 6-volt Light Switch. To the right of the 6-volt receptacle is a 6-volt light switch of toggle type. It controls the 6-volt instrument panel light which is located at the top of the panel.

t. 125-volt Light Switch. In the center of the panel beneath the volt-meter is a toggle-type 125-volt light switch. It controls the 125-volt instrument panel lights which are at the top of the panel.

u. Emergency Overload Switch. To the left of the circuit breaker is a push button type emergency overload switch. While depressed, it keeps the circuit breaker from opening the circuit during overload operation.

v. Load Terminal Box Cover. At the lower left corner of the instrument panel, the load terminal box cover gives access to the load terminal box.

w. Voltage Regulator Cover. The cover at the lower right corner of the panel gives access to the voltage regulator switch and voltage regulator adjustment facilities.

6. STARTING THE UNIT.

a. First Starting. For starting the unit for the first time, see paragraphs 4 and 11; then proceed as outlined below.

b. Preliminary Instructions.

- (1) Make sure that the circuit breaker is in the "OFF" position.
- (2) See that the fuel valve (located next to the gas tank in the fuel line) is open.
- (3) Remove exhaust pipe cap, and connect exhaust tube.
- (4) Remove power receptacle cap, and connect plug (fig. 2).
- (5) Be sure that the field rheostat knob has been turned counter-clockwise as far as possible.
- (6) Turn engine over with hand crank approximately three revolutions.

OPERATION AND CONTROLS

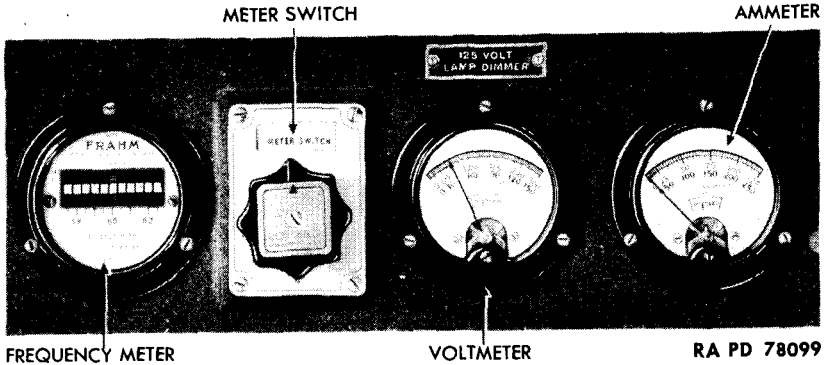

Figure 8 – Instruments Showing Correct Exciter Indication

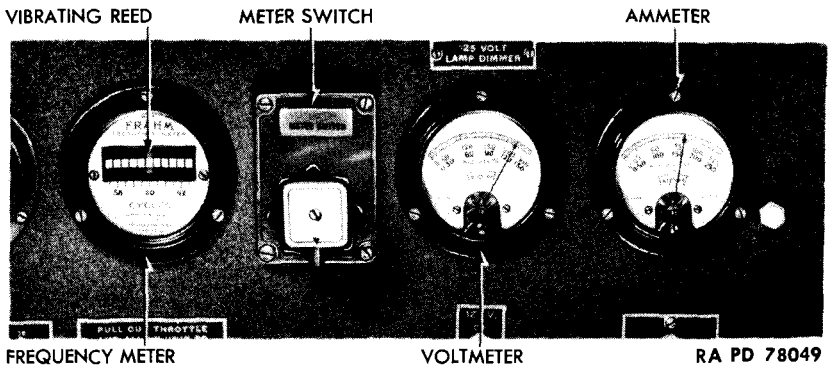

Figure 9 – Instruments Indicating Correct Reading for a Circuit Phase

c. Warming Up.

- (1) Pull out the choke, if necessary.
- (2) See that the throttle is pushed in all the way.
- (3) Start the engine by placing the ignition switch in the "ON" position and pressing the starter switch until the engine fires. If starting after all previous fuel has been drained or consumed, a longer period of time will be required before fuel reaches the carburetor and the engine fires. **NOTE:** On occasion, it will be found that oil has been added to the top of each cylinder of the power plant prior to shipment, to prevent rusting. When starting for the first time a unit which has been treated in this manner, smoking will most likely result until this oil is burned out.
- (4) When the engine fires, pull out the throttle quickly until the engine speed is about 600 rpm. Keep the engine at that speed until it is sufficiently warmed up for full speed operation; then gradually push in the throttle.

GENERATING UNIT M18

d. **Hand Crank Starting.** To start the generating unit with the hand crank, be sure both the load and ignition switches are in the "OFF" position. Pull choke all the way out; then give the hand crank two complete turns. Readjust choke so that it is one-third out, and turn ignition "ON." Give hand crank a quick turn by pulling up from the bottom.

7. OPERATING THE UNIT.

a. **Circuit Breaker.** The first step, to begin the delivery of current from the generator to the load connected to the power outlets, is to pull the circuit breaker handle (at extreme right on the instrument panel) to the "ON" position.

b. **Voltage Control.** Ascertain that voltage regulator switch is in "ON" position. To provide the requisite voltage for the power receptacle line (normally 125 for ordnance work), slowly rotate the field rheostat control handle clockwise as far as it will go. Use identical procedure to provide requisite voltage when operating unit at 250 volts. It is possible to operate the unit with the voltage regulator switch "OFF." When doing so, slowly turn rheostat handle clockwise until desired voltage is reached. Watch the voltmeter as the unit operates. If the voltage starts to increase, turn rheostat handle to the left; if voltage drops, turn rheostat handle to the right.

c. **Load Meter.** To check the voltage of the exciter, the amperage of the current being delivered to each of the three phases of the connected load, and the voltage between phases, the meter switch is provided. The four positions of the control knob, "EXC," "A," "B," and "C," are labeled on the face plate of the switch. When the indicating mark on the control knob is turned to "EXC," the exciter voltage is reflected on the voltmeter (fig. 8). As the switch turns to the "A," "B," and "C" phases of the circuit, the amperage and voltage show on the ammeter and voltmeter (fig. 9). The average of the three readings on the ammeter should not exceed 162 amperes for continuous operation, or 202 amperes over a period of operation not to exceed two hours. The difference in ammeter readings should not exceed 10 percent of the average. If the load is largely of the resistance type, such as lighting or heating units, so that the power factor is higher than 80 percent, the current must be limited to approximately 129 amperes normal load, and 162 amperes overload, in order not to exceed the rated capacity of the engine. For 250-volt operation, amperage readings should be one-half those given above.

d. Panel Illumination.

(1) Two 125-volt bulbs are located in rubber sockets at the top of the panel. The light switch is at the right of the center of the panel, and the lamp-dimming rheostat is located between the lights. In field service, the illumination should be kept as low as possible.

OPERATION AND CONTROLS

(2) As the 125-volt current is available only when the unit is operating, an auxiliary 6-volt light is provided at the top of the panel. A snap switch to control this is immediately above the choke handle.

e. Trouble Lights.

(1) The 125-volt trouble light, furnished with the unit and carried in the tool box, may be plugged into any one of the four T-slot receptacles on the lower right of the panel.

(2) The 6-volt trouble light (also in the tool box) has a receptacle provided for it to the right of the ignition switch.

f. **Power Tools.** Power tools that may be used for repair or maintenance work on the unit can be plugged into the T-slot receptacles in the lower right corner of the panel.

g. **Temperature Control.** The running temperature of the engine should be maintained at 160 F to 180 F. To maintain a correct temperature, the radiator doors, the engine side doors, and the door behind the instrument panel can be opened or closed to suit climatic conditions. All doors are provided with means for holding them in the "OPEN" position.

h. **Battery-charging Ammeter.** The battery-charging ammeter indicates in amperes the rate of charge or discharge of the two 6-volt batteries. It is of the automotive type. Its range is from positive 30 amperes to negative 30 amperes.

i. **Frequency Meter.** Normal engine speed (1,200 rpm) and a-c frequency output (60 cycles) are indicated when the reed over the 60-line on the instrument reaches its maximum vibration, with adjacent reeds vibrating less vigorously.

8. STOPPING THE UNIT.

a. **Circuit Breaker.** First operation in stopping the unit is to disconnect the load by pulling the circuit breaker handle down to the "OFF" position. When the unit is not in operation, this switch should always be off, thus avoiding the possibility of ever starting the engine with the load on.

b. **Rheostat.** The field rheostat knob should be turned counter-clockwise as far as possible.

c. **Throttle.** The throttle is pulled out to bring the engine down to idling speed *for the full minute of idling* required before stopping; otherwise, there is the chance of backfiring and muffler damage. The proper idling speed is 350 to 400 rpm.

d. **Ignition.** Final operation of stopping is to snap the ignition switch to the "OFF" position.

9. GENERAL CARE AND PRECAUTIONS.

a. The generating unit should be kept clean and adequately sup-

GENERATING UNIT M18

SAFETY RANGE

OIL LEVEL GAGE

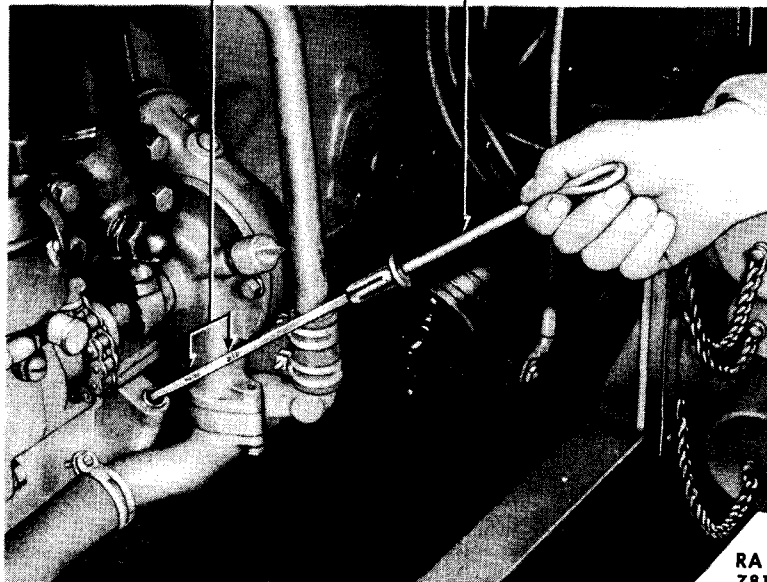
RA PD
78112**Figure 10 – Checking Oil Level**

plied with gasoline at all times. Lubrication and servicing should be in accordance with instructions set forth in sections IV and VI.

b. Exercise care to see that the main switch is always open, when connecting or disconnecting the power cable and before starting the engine.

c. If the unit is used in any building or enclosure, be sure that a hose or pipe is attached to the exhaust pipe and run through an opening to the outside. Exhaust fumes and gases might prove harmful to the operating personnel.

d. Periodic examinations should be made to see that all electrical connections and leads are in good order and that the electrical indicators and controls are functioning properly. When not in use, see that the receptacle cover is screwed on the outlet receptacle.

e. Do not pour gasoline into the fuel tank while the engine is running, nor while the ignition switch is turned on.

f. Never permit the oil to fall below the "2/4" mark on the bayonet gage (fig. 10). On the other hand, do not overfill the crankcase, as this might raise the oil level to a point where the connecting rods would dip in and throw oil on cylinder walls, causing smoke, oil pumping, excessive carbon deposits, and fouled spark plugs. Fill only to the "4/4" mark on the gage rod, except as indicated in section VI, for operation below zero F.

Section III
INSPECTION

	<i>Paragraph</i>
Purpose	10
Prestarting inspection	11
Inspection during operation	12
Inspection after short operation	13
Inspection after long operation	14
Weekly and monthly inspections	15

10. PURPOSE.

a. Inspection of the generating unit is vital. Thorough systematic inspection at regular intervals is the best insurance against an unexpected breakdown at the critical moment when maximum performance is absolutely necessary. Never let the materiel run down. Keep it in first class fighting condition by vigilant inspection and prompt maintenance.

b. Inspection is for the purpose of determining the condition of the materiel, whether repairs or adjustments are required, and the remedies necessary to insure serviceability and proper functioning. Its immediate aim is trouble prevention, which includes:

- (1) Preventive maintenance.
- (2) Discovering evidence of improper treatment of the materiel before receipt.
- (3) Determining when replacement of parts is necessary because of ordinary wear or accidents.

c. The Chief of Ordnance should be advised (through the local ordnance officer) of any chronic troubles, technical failures, or unsatisfactory operation of any parts or units. Any suggestions for the improvement of the inspection procedure or handling technique (based on actual operating experience) should likewise be forwarded so that all units may benefit.

11. PRESTARTING INSPECTION.

a. Check fuel supply, engine oil, water, or antifreeze solution in radiator, lubrication, and specific gravity of battery electrolyte. Inspect glass sediment cup on fuel pump; empty, if water is present.

b. Examine engine and trailer floor for leaks from radiator, fuel tank, water, fuel, or oil lines. Examine all lines for leaks.

c. Check unit for loose parts and loose electrical connections.

d. Check fuses and instrument panel lights.

e. Check tension on radiator fan belt.

f. Examine mounting and other important bolts, and tighten, if necessary.

g. Check fire extinguisher for fluid content.

GENERATING UNIT M18

- h.** See that the radiator core is clear.
- i.** See that the exhaust hose is in place on muffler outlet.
- j.** Make sure the circuit breaker is "OFF."
- k.** Make sure field rheostat is turned as far as possible in counter-clockwise direction.

12. INSPECTION DURING OPERATION.

a. Constant Attention. While the unit is running, the operator should be constantly alert to detect abnormal functioning. He should be trained to detect unusual engine noises. He should quickly be conscious of overheating or of the smell of burning insulation.

b. Instruments. All instruments should be inspected at regular intervals during operation. Special attention should be given to the amperage developed. Check the three phases of the circuit as described in paragraph 7 c. The battery-charging ammeter will not always indicate charging. If the battery is fully charged, the charging generator will not operate. Just after starting, however, the ammeter should indicate charging.

13. INSPECTION AFTER SHORT OPERATION.

a. General. The inspection after a short period of operation should roughly duplicate the prestarting inspection, with the addition of a check of running parts.

b. Leaks, etc. Examine fuel, water, and oil lines for leaks. Fill the fuel tank. If necessary, change the engine oil, or add oil to maintain the correct level (fig. 10). Add water or antifreeze solution to radiator, if required (par. 4 c).

c. Running Parts. Check all running parts for evidence of overheating. Examine electric wiring for breaks or loose connections. The best check on running parts is made after a short period of operation. Insert the hand crank for hand starting. Running parts are functioning freely if the crank can be turned without too much effort.

d. Nuts and Bolts. Check tightness of bolts and nuts.

14. INSPECTION AFTER LONG OPERATION.

a. General. After each lengthy period of operation, an exhaustive check should be made for any actual or incipient failure of parts or equipment. Replacements made from the spare parts supply should be listed for renewal.

b. Lines. All tubing and pipe lines must be examined for leaks. Joints and fittings must be tested for tightness. Gaskets must be checked, and replaced where necessary.

c. Electrical. Electrical equipment, including all switches and instruments, must be subjected to a thorough examination and test.

INSPECTION

d. **Clearances.** Spark plug and distributor point clearances must be checked.

e. **Lubrication.** Special attention must be given to the lubricating system (secs. IV and XIII).

f. **Tools and Fire Extinguisher.** Tools are checked against the tool list, and missing tools reported. The fire extinguisher must be examined, and a part of its contents discharged into a clean, dry glass jar to ascertain that it works properly. Remove hexagonal filler cap from top of extinguisher and pour contents back into extinguisher. Replace extinguisher if it fails to function. Refill, if necessary, to maintain fluid level to within approximately $\frac{3}{4}$ inch of top.

g. Check battery electrolyte (par. 74 b).

h. Examine belts for wear, or for the necessity of adjustment.

i. Check light bulbs and fuses.

j. Examine muffler for cracks.

15. WEEKLY AND MONTHLY INSPECTIONS.

a. Inspections at stated intervals, regardless of the amount of actual service the unit has given during the period, are valuable because they will bring to light not only operational mechanical failures, but also troubles due to deterioration which can occur even when the unit has not been in operation.

b. Weekly inspections will at least duplicate the inspection after long operation. In these weekly inspections, the possible effects of unusual climatic conditions or conditions of terrain should be taken into consideration and checked as detailed in section VI.

c. Monthly inspections should be the most exhaustive possible. Check list is given below:

(1) **FRAME AND CANOPY.** Examine connecting nuts and bolts for tightness.

(2) **ENGINE.**

(a) Check crankcase, block, head, and head gasket for cracks or leaks. See that all bolts are tight.

(b) Run engine, and listen for piston slap, bearing knock, or carbon knock.

(c) Check oil pressure. If below normal, it may indicate loose engine bearings.

(3) **COOLING SYSTEM.**

(a) Examine radiator and connections for signs of leakage, clogging, or damage.

(b) Inspect fan and supporting bracket.

(c) Check fan belt for proper tension, for cracks, or for oil soaking.

(d) Examine water pump for cracks and leaks. Make sure the shaft rotates freely.

(4) **EXHAUST SYSTEM.**

GENERATING UNIT M18

- (a) Examine manifold for cracks.
- (b) Check manifold gaskets for leaks.
- (c) Examine muffler and exhaust pipe for cracks.

(5) FUEL SYSTEM.

(a) Inspect fuel pump, fuel pump mounting, and connections. Empty the sediment cup, and clean the fuel filter.

(b) Examine carburetor for tightness of screws, and for worn gaskets.

(c) Inspect air cleaner. Clean element, and change oil.

(d) Check choke and throttle action, and examine linkage.

(e) Inspect fuel tank and fuel lines for signs of leaks.

(6) LUBRICATING OIL SYSTEM.

(a) Check oil pressure.

(b) Check all oil lines and connections to governor and to oil pressure gage.

(c) Clean oil filter.

(7) ENGINE ELECTRICAL SYSTEM.

(a) Inspect all wires and terminals for damage, wear, and looseness.

(b) Test battery, and check battery electrolyte.

(c) Inspect distributor. Remove cap and examine for cracks. Inspect breaker points, spring, rotor, and cap inserts for signs of pitting and burning. Check cam for evidence of wear.

(d) Test the action of the starting motors. Inspect commutator and brushes for dirt or signs of wear. Test starter switch.

(e) Check battery-charging generator action for excessive arcing at the brushes. Examine for sticking or worn brushes, and burned commutator bars.

(8) GENERATING SYSTEM.

(a) Check amperage and voltage of current delivered. Inspect alternator brushes for signs of wear, proper spring pressure, and freedom of action in holders. Examine brush holders to see if they are clean.

(b) Check exciter brushes for signs of wear, proper spring pressure, and freedom of action in holders. Inspect condition of brush holders, brush holder rod insulating washers, and pigtail connections. Check commutator for roughness or low, loose, or high bars.

(9) INSTRUMENT PANEL.

(a) Check tightness of mounting bolts.

(b) Inspect for loose wires or connections.

(c) Check all fuses.

Section IV
LUBRICATION

	Paragraph
Introduction	16
Lubrication guide	17
Reports and records	18

16. INTRODUCTION.

a. Lubrication is an essential part of preventive maintenance, determining to a great extent the serviceability of parts and assemblies.

17. LUBRICATION GUIDE.

a. **General.** Lubrication instructions for this materiel are consolidated in a lubrication guide (fig. 11). These specify the points to be lubricated, the periods of lubrication, and the lubricant to be used. In addition to the items on the guide, other small parts such as hinges and latches must be lubricated at frequent intervals. All lubrication points on the materiel are readily identified by their being painted red. These points will be wiped clean before lubricant is applied.

b. **Supplies.** In the field it may not be possible to supply a complete assortment called for by the lubrication guide to meet recommendations. It will be necessary to make the best use of those available, subject to inspection by the officer concerned, in consultation with responsible ordnance personnel.

c. **Intervals.** Service intervals specified on the guide are for normal operating conditions. The intervals will be reduced under conditions such as excessively high or low temperatures, continued operation in sand or dust, immersion in water or exposure to moisture, any one of which may quickly destroy the protective qualities of the lubricant.

d. **Temperature Ranges.** Lubricants are prescribed in the "Key" in three temperature ranges, "above ± 32 F," " $+ 32$ F to zero F," and "below zero F." When to change grades of lubricants is determined by maintaining a close check on operation of the generating unit during the approach to change-over periods, especially during initial action. Sluggish starting is an indication of lubricants thickening and the signal to change to grades prescribed for the next lower temperature range. Ordinarily, it will be necessary to change grades of lubricants *only when air temperatures are consistently in the next higher or lower range*, unless malfunctioning occurs sooner due to lubricants being too thin or too heavy.

e. **Lubrication Notes.** The following notes apply to the lubrication guide (fig. 11). Any note reference in the lubrication guide itself is to the step below having the corresponding number.

(1) **AIR CLEANER AND BREATHER.** Daily, check level and refill engine air cleaner and breather oil reservoirs to bead level with used crankcase oil or OIL, engine, SAE 30, above $+ 32$ F and OIL, engine,

GENERATING UNIT M18

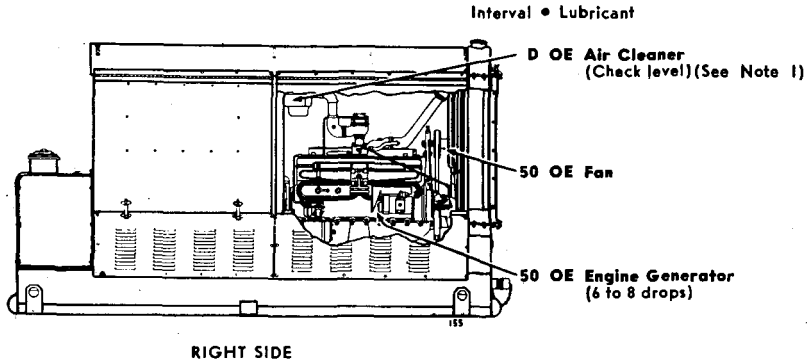
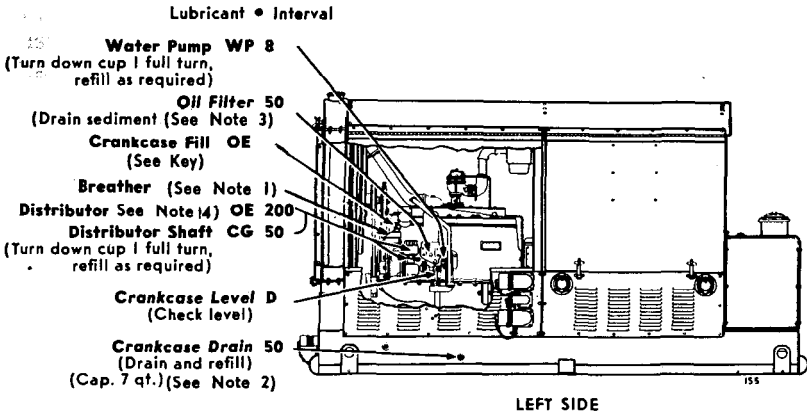

— KEY —

LUBRICANTS	LOWEST ANTICIPATED AIR TEMPERATURE		
	above +32°F.	+32°F. to 0°F.	below 0°F.
OE—OIL, engine			
Crankcase	OE SAE 30	OE SAE 10	See OFSB 6-11
Other Points	OE SAE 30	OE SAE 10	PS
CG—GREASE, general purpose	CG No. 1	CG No. 0	CG No. 0
WP—GREASE, water pump—All temperatures			INTERVALS
OH—OIL, hydraulic—All temperatures			D—Daily
SA—FLUID, shock-absorber, light—All temperatures			8—8 hours
PS—OIL, lubricating, preservative, special—All temperatures			50—50 hours
			200—200 hours

COLD WEATHER: For Lubrication and Service below 0°F., refer to OFSB 6-11.

RA PD 15687

Figure 11 – Lubricating Guide – Generating Unit M18

LUBRICATION

SAE 10, from +32 F to zero F. From zero F to —40 F, use either OIL, hydraulic, or FLUID, shock-absorber, light. Below —40 F, remove oil and operate dry. Every 150 hours, and daily under extreme dust conditions, remove air cleaner and breather, and wash all parts.

(2) **CRANKCASE.** Daily, check level and refill to "FULL" mark with OIL, engine, SAE 30, above +32 F or OIL, engine, SAE 10, from +32 F to zero F. Below zero F, refer to section VI of this manual. Every 50 hours, remove crankcase drain plug on left side of frame and completely drain case. Drain only when engine is hot. After thoroughly draining, replace drain plug and refill crankcase to "FULL" mark on gage with correct lubricant to meet temperature requirements. Run engine a few minutes and recheck oil level. Be sure pressure gage indicates oil is circulating.

(3) **OIL FILTERS.** Every 50 hours, remove drain plug from oil filter to drain sediment. After draining, remove check valve cap at top and blow out additional sediment with air hose. Disassemble and wash all parts and scrape sludge from filter felts. After reassembly, run engine a few minutes, recheck crankcase oil level, and fill to "FULL" mark with the correct grade of OIL, engine.

(4) **DISTRIBUTOR.** Every 200 hours, wipe breaker cam lightly with GREASE, general purpose, No. 1, above +32 F and GREASE, general purpose, No. 0, below +32 F, and lubricate breaker arm pivot, wick under rotor, and governor weight pivots and slots with 1 to 2 drops of OIL, engine, SAE 30, above +32 F, OIL, engine, SAE 10, from +32 F to zero F, or OIL, lubricating, preservative, special, below zero F.

(5) **OILCAN POINTS.** Every 50 hours, lubricate throttle and governor linkage, hood hinges, and latches with OIL, engine, SAE 30, above +32 F, OIL, engine, SAE 10, from +32 F to zero F, or OIL, lubricating, preservative, special, below zero F.

(6) **DO NOT LUBRICATE.** Governor, flexible coupling, starters and a-c generator.

18. REPORTS AND RECORDS.

a. **Reports.** If lubrication instructions are closely followed, proper lubricants used, and satisfactory results are not obtained, a report will be made to the ordnance officer responsible for the maintenance of the unit.

b. **Records.** A complete record of lubrication servicing will be kept in the Artillery Gun Book for the materiel.

GENERATING UNIT M18

Section V

TOOLS AND EQUIPMENT

	Paragraph
Introduction	19
Tools	20
Accessories	21
Fire extinguisher	22

19. INTRODUCTION.

a. The materiel described herein includes tools and equipment for general care, maintenance, and preservation. Accessories should not be used for purposes other than as prescribed and, when not in use, should be stored in the places or receptacles provided.

20. TOOLS.

a. **Service Tools Supplied with the Generating Unit.** The following tools are carried in the tool box:

- FILE, ignition contact
- GAGE, spark plug gap with cloth bag
- OILER, 3-inch spout screwdriver, "L"-shaped, 6 inches long
- PLIERS, combination, 6-inch
- PUNCH, drive pin, $\frac{3}{8}$ -in.
- ROLL, tool, 10-oz canvas, 16 pockets
- SCREWDRIVER, common, 3 inches long
- SCREWDRIVER, common, 6 inches long
- WRENCH, engineer's, $\frac{3}{8} \times \frac{7}{16}$
- WRENCH, engineer's, $\frac{7}{16} \times \frac{1}{2}$
- WRENCH, engineer's, $\frac{1}{2} \times \frac{9}{16}$
- WRENCH, engineer's, $\frac{9}{16} \times \frac{5}{8}$
- WRENCH, engineer's, $\frac{5}{8} \times \frac{3}{4}$
- WRENCH, engineer's, $\frac{3}{4} \times \frac{15}{16}$
- WRENCH, engineer's, $\frac{15}{16} \times 1\frac{1}{16}$
- WRENCH, engineer's, $1\frac{1}{4} \times 1\frac{7}{16}$
- WRENCH and GAGE, ignition, $\frac{1}{4}$ -in. opening
- WRENCH, spark plug, $1\frac{1}{2}$ and $1\frac{5}{32}$ including handle

b. **Spare Parts Supplied with the Generating Unit.** The following parts are stowed in the tool box:

- BELT, fan
- BRUSH, B178788
- BRUSH, B178789
- BRUSH, battery charging generator
- BRUSH, starting motor
- FUSE, (5-amp) battery charging generator
- FUSE, renewable, enclosed cartridge, 25 amp, 250 volts
- LAMP, 3-cp, single contact, bayonet base

TOOLS AND EQUIPMENT

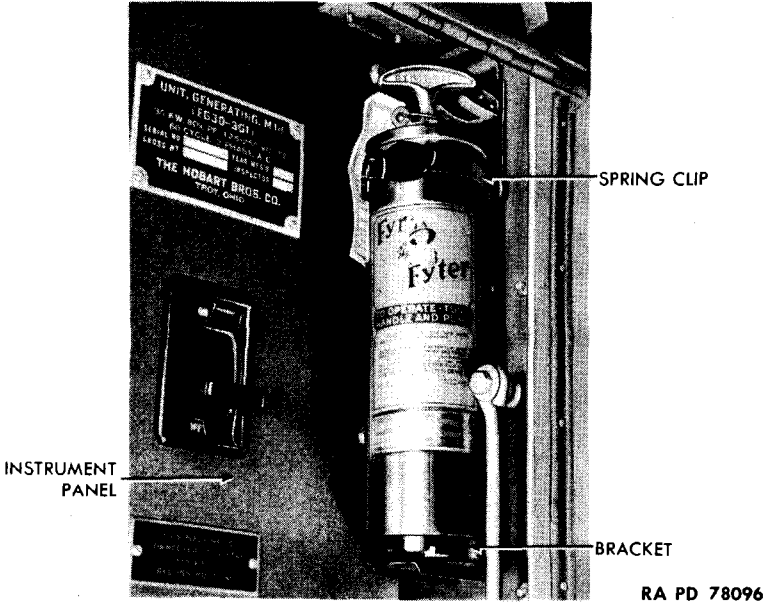

Figure 12 – Fire Extinguisher – Installed

LINK (for FUSE, renewable, enclosed cartridge, 25 amp, 250 volts)
PLUG, spark
POINT, breaker

21. ACCESSORIES.

Accessories	Where Carried
Crank	Left side panel
Fire extinguisher, 1-qt	To right of instrument panel
Light, trouble, 6-volt	Tool box
Light, trouble, 125-volt	Tool box
Oilcan, 3-in. spout	Rear of engine compartment, right side
Waste, cotton, 6 oz	Tool box

22. FIRE EXTINGUISHER.

a. **Location.** The fire extinguisher, filled with a CARBON TETRACHLORIDE solution, is located to the right of the instrument panel (fig. 12).

b. **Operation.** Hold barrel in left hand and point base of extinguisher at source of flame. Operate handle with right hand, first unlocking by a turn in either direction.

c. **Refilling.** Remove hexagonal filler cap, and fill to within $\frac{3}{4}$ inch of top with CARBON TETRACHLORIDE. Replace cap.

GENERATING UNIT M18

d. **Maintenance.** At least once a year, the extinguisher should be partially discharged and refilled. Replace extinguisher if it fails to function properly.

Section VI

OPERATION UNDER UNUSUAL CONDITIONS

	Paragraph
Cold weather maintenance	23
Gasoline for low temperatures	24
Engine lubrication	25
Protection of cooling system	26
Protection of electrical system	27
General conditions	28
Starting and operation	29
Cold weather accessories	30
Extreme heat	31
Desert conditions	32
Flood conditions	33
Deep water fording	34

23. COLD WEATHER MAINTENANCE.

a. Operation and maintenance of the unit at low temperatures involve factors not found at normal operating temperatures, and operators must devote more time to protective maintenance. Failure to provide extra service will result in actual damage, unnecessary and unwarranted expense, and failure to start.

b. Low temperatures have been divided into two ranges: Zero degree F to -30 F, and below -30 F. Engines and lubricants undergo changes in their physical properties below -30 F. In many cases, accessory equipment for supplying heat to engine, fuel, oil, and intake air is required.

24. GASOLINE FOR LOW TEMPERATURES.

a. **Selection.** Use the winter class of motor fuel procured under U. S. Army Specification 2-103, latest issue.

b. The formation of ice crystals from small quantities of water in the fuel sometimes causes considerable trouble. To keep water out of the fuel tank, observe the following precautions:

(1) Strain the gasoline through a suitable strainer. **CAUTION:** Be sure to provide a positive metallic contact between fuel container and gasoline tank, unless both fuel tank and container are independently grounded.

(2) In so far as possible, always keep the fuel tanks full. This will

OPERATION UNDER UNUSUAL CONDITIONS

reduce condensation of water from the free air space above the fuel.

(3) Add $\frac{1}{2}$ pint of denatured alcohol to a tank of gasoline. The alcohol will absorb the water and prevent it from freezing.

(4) Do not store fuel in old drums unless they have been thoroughly cleaned.

(5) Never pump fuel drums dry when filling vehicle fuel tanks; allow about 4 inches of fuel to remain. This residue can later be transferred to a settling tank. If time is not an urgent factor, do not pump fuel from drum to unit until it has settled for 16 hours after filling or moving the drum. Keep portable fuel pumps clean and protected from snow and frost.

(6) When a drum has been opened, be sure to cover the opening or replace the bung to keep out snow, frost, or other foreign matter. Store drums in a covered building or cover with a tarpaulin.

25. ENGINE LUBRICATION.

a. Engine lubrication at temperatures above zero degree F is covered in the lubrication guide. The following instructions supplement this information, and apply only to instances where the temperature falls below zero degree F for long periods.

b. Several methods of keeping engine oil sufficiently fluid for proper lubrication at temperatures below zero degree F are listed below. Give preference to these methods in the order listed according to available facilities.

(1) Keep the unit in heated enclosure when not in operation.

(2) When engine is stopped, drain crankcase oil while it is hot, and store in a warm place until unit is to be operated again. If warm storage is not available, heat the oil before reinstalling. (Avoid overheating the oil; heat only to the point where the bare hand can be inserted without burning.) *Tag the Unit in a Conspicuous Place to Warn Personnel that Crankcase Is Empty.* Close shut-off valves to prevent flooding of the carburetor, and crankcase dilution because of the accumulation of gasoline vapor pressure in the gasoline tanks.

(3) If unit is to be kept outdoors, and if the oil cannot be drained, cover the engine with a tarpaulin. About 3 hours before engine is to be started, place fire pots under the tarpaulin. Use the Van Prag, Primus type, or other type blowtorch, or ordinary kerosene lanterns.

(4) Engine lubricating oil will be OIL, engine, SAE 10, diluted with gasoline or SOLVENT, dry-cleaning. Since the diluent will tend to evaporate when the oil becomes warm, the oil level may go down rapidly, and must be maintained by adding oil and diluent:

(5) The following procedure should be followed to provide the engine with properly diluted engine oil for cold starting:

(a) With the oil level at "FULL" mark and the engine warm, add a quantity of gasoline or SOLVENT, dry-cleaning, equal to 20 per-

GENERATING UNIT M18

cent (one-fifth) of the normal crankcase capacity, for operation at zero degree F. With a 7-quart capacity crankcase add 1.4 quarts of diluent for zero degree F to -30 F, or 2.1 quarts of diluent for below -30 F.

(b) Run engine 5 to 10 minutes to mix oil and diluent thoroughly, and stop engine.

(c) After stopping, note level of crankcase oil on oil level gage stick. Level will be above normal "4/4" mark. It is advisable to mark this increased level on the gage for future reference. **CAUTION:** Do not add diluent while engine is running. If any diluent is spilled on the engine, it must be wiped dry before starting.

(6) The following procedure should be used when operating the generating unit at sub-zero temperatures:

(a) At end of each operating period, check oil level.

(b) If oil level is below normal full "4/4" mark, add necessary quantity of undiluted OIL, engine, SAE 10, to bring level to "4/4" mark. Then add the necessary quantity of gasoline or SOLVENT, dry-cleaning, to raise level to the mark recorded in step (5) (c), above. If oil level on stopping is at or above "4/4" mark, add enough gasoline or SOLVENT, dry-cleaning, to bring level to mark recorded in step (5) (c), above.

26. PROTECTION OF COOLING SYSTEM.

a. Antifreeze Solution.

(1) In freezing weather, protect the cooling system by addition of an antifreeze solution, employing COMPOUND, antifreeze (ethylene glycol type).

(2) The table in paragraph 4 gives the approximate quantity of antifreeze necessary for various temperature conditions; however, check with an antifreeze solution hydrometer.

b. Precautions.

(1) Do not mix antifreeze solutions.

(2) Before installing antifreeze solution:

(a) Thoroughly flush the cooling system (par. 51 d).

(b) Check system for leaks; tighten hose connections, and replace if necessary; check thermostat and water pump. Make sure that the pump is properly lubricated.

(c) Check fan belt for adjustment or weakness. Do not use rubber fan belts at temperatures below -20 F. Use leather, fiber, or synthetic rubber fan belts.

27. PROTECTION OF ELECTRICAL SYSTEM.

a. **Generator and Starter.** Inspect brushes and commutators. See that the commutators are clean. Large surges of current, which occur when starting a cold motor, require good contact between brushes and commutators.

OPERATION UNDER UNUSUAL CONDITIONS

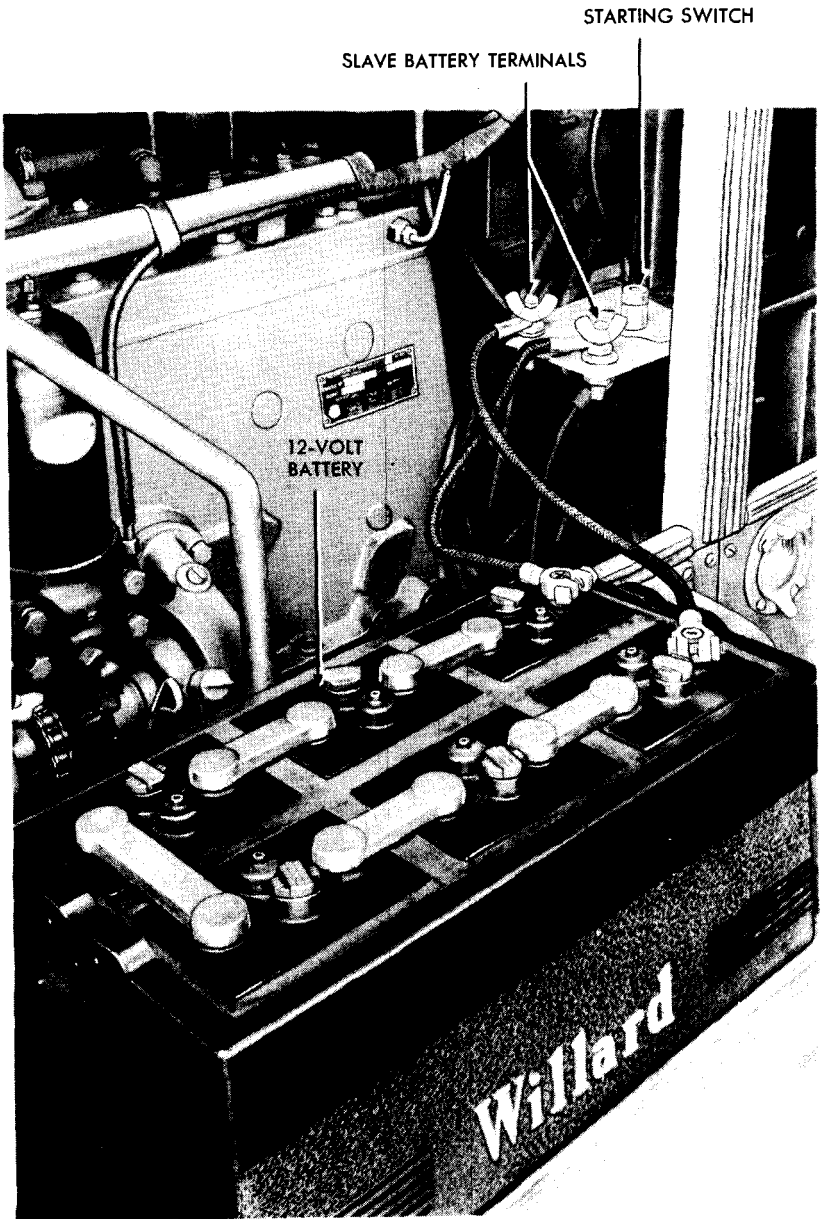

RA PD 78101

Figure 13 — Method of Connecting Additional Battery

GENERATING UNIT M18

b. **Wiring.** Inspect and clean all connections, especially the battery terminals. Take care that no short circuits are present, or that there is no ice on the spark plugs, wiring, or other electrical equipment.

c. **Coil.** Check coil for proper functioning.

d. **Distributor.** Clean thoroughly, and clean or replace points. Check the points frequently. In cold weather, current is heavier, and the points may pit and burn more than usual.

e. **Spark Plugs.** Clean, test, and replace if necessary. If it is difficult to make the engine fire, reduce gap 0.005 inch more than that specified for normal operation. This will make sparking easier at the reduced voltages likely to prevail.

f. **Timing.** Check carefully. Take care that the spark is not unduly advanced or retarded.

g. **Batteries.**

(1) The efficiency of batteries decreases sharply with decreasing temperatures, and becomes practically nil at -40 F. Do not attempt to start the engine with the batteries when it has been exposed to temperatures below -30 F, until the batteries have been warmed. When operating in temperatures below zero F, it is best to remove the batteries to a warm place, if the generating unit will not be used for a period of hours.

(2) Fully charged batteries will not freeze at temperatures likely to be found even in Arctic climates, while fully discharged batteries will freeze and rupture at approximately 18 F. See that the batteries are always fully charged with hydrometer reading between 1.275 and 1.300 (fig. 48). If a hydrometer is not available, use ammeter and voltmeter to determine battery condition.

(a) Due to the action of the generator regulator, the ammeter reading at constant engine speed will be low when the batteries are fully charged, and high when the batteries are weak or discharged. To obtain an indication of battery condition, frequently check ammeter readings at approximately equal engine speeds.

(b) Voltmeter readings, taken at intervals with the same load on the batteries, will provide a clue to potential battery performance.

(3) Maintain electrolyte level $\frac{3}{8}$ inch above top of plates in each battery. If necessary to add distilled water, wait until the engine and battery have warmed up. Keep ventholes in filler plugs open. Keep terminals tight and clean. At regular intervals, apply a coating of GREASE, general purpose, No. 0, or COMPOUND, rust-preventive, light, to terminal connections.

(4) Provision is made in the design of this generating unit for easy attachment of an additional 12-volt battery when needed to facilitate starting. Two slave terminals are provided on the starter switch bracket. Connect lead from negative post or battery to right-hand

OPERATION UNDER UNUSUAL CONDITIONS

slave terminal (one nearest engine). Connect positive lead to left-hand slave terminal (fig. 13).

28. GENERAL CONDITIONS.

a. Make sure that no heavy grease or dirt has been left on the starter Bendix drive mechanism of either starter. Heavy grease or dirt may keep the gears from being meshed, or cause them to remain in mesh after the engine starts and thus ruin the starter.

b. Pull the choke control all the way out to secure the air-fuel ratio required for cold weather starting. Make sure the butterfly valve in the carburetor closes all the way and otherwise functions properly.

c. Carburetors, which give no appreciable trouble at normal temperatures, may not operate satisfactorily at low temperatures. A fuel pump, which will deliver enough gasoline at normal starting speeds of 400 rpm, may have leaky valves or a diaphragm which will prevent it from delivering a sufficient quantity of fuel at cranking speeds of 30 to 60 rpm. Another source of trouble is a flooded carburetor condition, caused by the improper seating of the carburetor float needle valve.

d. At temperatures below zero degree F, operate generating unit, with air cleaner and breather serviced as specified in paragraph 17 e (1). Ice and frost formations on the air cleaner screens may cause an abnormally high intake vacuum and an overrich mixture.

e. Inspect the unit frequently. Shock resistance of metals, or resistance against breaking, is greatly reduced at extremely low temperatures. Movement of units on hard, frozen ground causes strain and jolting which will loosen or break bolts and nuts.

f. Remove oil filter element at temperatures below -30 F, because the viscous oil will not flow freely through them.

g. Remove and clean gasoline strainer at frequent intervals.

29. STARTING AND OPERATION.

a. Temperatures from Zero Degree F to -30 F.

(1) It is possible to start gasoline engines with batteries at temperatures as low as -30 F, if the engines are properly lubricated and in good mechanical condition.

(2) To insure that the engine will start on the first attempt, proper preparation of the engine is very important. Should the engine fire a few times and stop, water vapor, which is a product of combustion, may form frost in the combustion chamber, and make it impossible to start without heating the engine to above 32 F. Prolonged starting efforts wear down the battery. It is well to give the engine a few turns with the hand crank before turning on the ignition.

(3) Pull the choke lever all the way out for starting, and keep it partially pulled out until the engine has warmed up. Since only the

GENERATING UNIT M18

lightest components of the gasoline vaporize in a cold engine, a very rich mixture is necessary.

(4) When attempting to start, turn the engine over as rapidly as possible. All engines have a critical cranking speed; that is, the engine must be turned over at a certain rate of speed before any start at all is possible. For engines in good mechanical condition, this critical rate of speed may vary from 40 to 70 rpm. If necessary, use an additional 12-volt battery (par. 27 g (4)) to assist attaining critical cranking speed.

(5) After the engine is started, idle it at approximately 600 rpm until it has warmed up enough to run smoothly. Do not place the unit in operation until its minimum operating temperature of 160 F has been reached.

(6) When exercising generating units, they must be run for at least 30 minutes, and preferably for 1 hour under load. Shorter operating periods will inevitably cause the formation of moisture in the crankcase. This moisture then combines with carbon and dirt to form sludge in the crankcase which may cause bearing failures. Also the moisture will freeze and prevent circulation of oil. During these exercising periods, the radiator should be covered to give rapid warm-up, and to maintain engine and oil temperatures at normal values. After stopping, all covers should be kept in place to hold engine temperature as high as possible during the shut-down period.

b. Temperatures Below -30 F.

(1) Cover engine with tarpaulin, tent, or portable shed. Place oil stoves, fire pots, or four or five ordinary kerosene lanterns under the covering about 3 hours prior to starting time.

(2) Keep unit in sheltered area, shielded from wind. Cold winds increase starting difficulties.

(3) Ice may collect in the fuel line. If the engine does not appear to be getting enough fuel, heat the fuel line lightly, *but be alert for fires.*

30. COLD WEATHER ACCESSORIES.

a. A number of the most commonly used accessories have been mentioned in the preceding sections. These, together with other accessories and attachments used successfully in northern climates, are listed below. The use of these accessories is not mandatory. They are given only as suggestions, and are to be used at the discretion of officers in charge of the materiel.

(1) Tarpaulins, tents, or collapsible sheds are useful for covering the unit.

(2) Fire pots (Primus type) or Van Prag blowtorches, ordinary blowtorches, oil stoves, or kerosene lanterns can be used for heating unit.

OPERATION UNDER UNUSUAL CONDITIONS

(3) Extra batteries and facilities for changing batteries quickly help in starting.

(4) Steel drums and suitable metal stands are useful for heating crankcase oil.

(5) Insulation for the fuel line helps prevent ice formation inside the line.

(6) Radiator covers, improvised locally, help keep the engine running at normal temperatures. In very cold weather, the radiator doors may be left closed while the engine is started. When the engine is warmed up, the doors may be adjusted in the position that experiment will prove most satisfactory.

31. EXTREME HEAT.

a. **Doors.** When operating in very hot climates, it is extremely important to maintain correct engine temperature. Radiator doors, of course, will be left open, and, while the engine is running, the instrument panel door shall be open. The other doors may experimentally be opened and closed, until the desired engine temperature is obtained. It will probably be found that closing all the canopy doors will create the best direct air circulating condition, with the air drawn by the action of the fan up through the frame, across the engine, and out through the radiator.

b. **Batteries.** The specific gravity and temperature of the battery electrolyte should be maintained. In hot climates, batteries tend to self-discharge, if they are not in use.

c. **Fuel Tank.** The humidity that often accompanies extreme heat creates condensation on metal. For this reason, it is best to keep the fuel tank filled to capacity at all times. Considerable water from condensation will collect in the tank if it is allowed to remain partially empty. Water may be drained from the tank through the drain plug provided.

d. **Ignition System.** In humid atmospheres, spark plugs, ignition coil, distributor, and wire and cable terminals should be frequently wiped dry of condensation moisture.

32. DESERT CONDITIONS.

a. **General.** When operating in regions which approximate conditions found in a desert, the care necessary for hot climates and also precautions against sand are required. To guard against dust and sand storms, protective breaks and coverings should be rigged. All operating parts should be cleaned constantly. The utmost care should be taken to keep particles of sand and grit out of the engine, generator, exciter, instruments, etc.

b. **Fuel System.** The fuel tank cover should be kept tight at all times. The top of the cap shall be frequently taken off and the vent slots cleaned. The fuel strainer must be cleaned frequently, and, if

GENERATING UNIT M18

necessary, the fuel lines blown out. The air cleaner element must be given constant attention to insure a regular air flow.

c. Lubrication System. The oil filler cap must be kept tight and the bayonet-type oil gage must be kept firmly in place. The oil filter should be cleaned often, with an air hose or by scraping the element, and by draining at the sludge plug in the filter base. The breather must frequently be removed and serviced.

33. FLOOD CONDITIONS.

a. General. During periods of continual rainfall, and when operating in flooded regions, the principal chances for trouble lie in the generating and ignition systems. While the unit is in operation, the heat of the engine will tend to keep dry the sources of potential trouble. When the unit is not operating, it should be given every protection possible to keep water and moisture from collecting inside the canopy. Doors must be kept closed at all times and, if possible, tarpaulins or other protective coverings shall be used outside the canopy. Before starting, the generating and ignition systems and all terminals and connections should be wiped dry.

b. Generator. Before starting, the generator should be dried out as thoroughly as possible. If necessary, the brush guard must be removed, and all parts within reach wiped dry. All brushes must be wiped dry. Use compressed air to dry portions of generator which are hard to reach.

c. Ignition System. Practically all parts of the ignition system can be damaged by water. Spark plugs should be removed and carefully dried. The distributor leads must be disconnected and dried, and all parts of the distributor must be thoroughly dried. Battery leads, ignition coil leads, and all other wiring must be dried prior to starting. The instrument panel should be wiped dry, and all connections at the rear should be inspected and dried, if necessary.

34. DEEP WATER FORDING.

a. General.

(1) These instructions are designed to protect the generating units against complete immersion during deep water fording operations or surf landings, and still permit immediate use of the units after landing. They will serve as a general guide for supplementing supervision of actual waterproofing by trained personnel. Only the significant points are covered in the detailed instructions.

(2) Necessity for extreme care in all steps cannot be overemphasized. Every seam, joint, or opening must be completely sealed. When waterproofing is completed, the units should be carefully inspected to make sure all openings and parts have been properly treated.

OPERATION UNDER UNUSUAL CONDITIONS

b. Servicing Prior to Waterproofing.

- (1) Clean housing thoroughly.
- (2) Lubricate all points ordinarily lubricated, daily, and after 8-, 50-, and 200-hour operations, in accordance with the lubrication instructions in section IV of this manual.
- (3) Tighten bolts and nuts in all covers and openings, such as electric receptacle bodies, housing screws, etc.
- (4) Remove all oil and grease from points to which waterproofing compound or materials are to be applied.

c. Waterproofing (Units Mounted in Trailers).

- (1) Cut wood blocks to fit between skids at both front and rear of unit. Drive these blocks in the openings between the unit and the trailer floor. Seal the openings around these blocks with asbestos grease.
- (2) Drive wood pegs in holes in floor of trailer, and seal with asbestos grease.
- (3) Close all doors, and seal edges with waterproofing tape. Close and seal radiator doors with waterproof tape.
- (4) Cover all seams and cracks in unit with tape, and seal all bolts with asbestos grease.
- (5) Cover electric brake breakaway switch with asbestos grease. Disconnect the chain during travel in water. Remove electric brake cable, and seal cable socket with asbestos grease. Disconnect brakes during travel in water.
- (6) Seal gas tank filler opening and gas gage with waterproof tape. Seal all cracks around gas tank cover with asbestos grease.
- (7) Seal all junction boxes and cable connections on trailer and in trailer side compartments with asbestos grease.
- (8) Screw power receptacles tight, and seal with asbestos grease.
- (9) Place exhaust cover on pipe, and seal with asbestos grease.
- (10) Seal lenses and all cracks around guide. Remove and seal all stop lamps with asbestos grease.

d. Waterproofing (Units Mounted on Skids). Use the same procedure as directed for units mounted in trailer (subpar. c, above) with the following exceptions:

- (1) Drive wood blocks in between unit and floor of the truck which is carrying the unit.
- (2) Apply a heavy coat of asbestos grease to all contact points between unit and truck floor, so the joints will remain sealed, despite small movement caused by uneven terrain.

e. Material Required.

- GREASE, asbestos 7½ lb
- Substitutes are GREASE, water pump, and COMPOUND, rust-preventive, heavy.
- TAPE, adhesive, nonhygroscopic, 6 in. wide, 4 in. wide ½ roll
- SOLVENT, dry-cleaning As required

GENERATING UNIT M18

f. Preparation for Operating Unit.

(1) IMMEDIATE ACTION.

- (a) Remove all waterproofing material from doors, and open doors.
- (b) Clean all electric receptacles and plugs to insure good connection.
- (c) Start gasoline engine, allow engine to warm up, and check for normal operation.

(d) Connect cables in normal manner, and check main generator output.

(2) COMPLETE DEWATERPROOFING AS SOON AS TIME AND FACILITIES ALLOW.

- (a) Remove all waterproofing material.
- (b) Clean the asbestos grease from all the surfaces with SOLVENT, dry-cleaning.
- (c) Remove wheels, clean and relubricate wheel bearings.
- (d) Clean and lubricate, in accordance with the lubrication instructions in section IV of this manual, all points to be covered at all intervals.

PART TWO
ORGANIZATIONAL MAINTENANCE INSTRUCTIONS

Section VII
TROUBLE SHOOTING

	Paragraph
General	35
Engine	36
Cooling system	37
Starting system	38
Ignition system	39
Batteries and generating system	40
Fuel system	41
Engine lubrication system	42
Lighting system	43
A-C generating system	44

35. GENERAL.

a. This section contains trouble shooting information and tests which can be made to help determine the causes of some of the troubles that may develop in this generating unit. Each symptom of trouble given under the individual unit or system is followed by a list of possible causes of the trouble. The tests necessary to determine which one of the possible causes is responsible for the trouble are explained after each possible cause.

36. ENGINE.

a. Engine Will Not Turn.

(1) **HYDROSTATIC LOCK, WATER OR EXCESSIVE ANTIRUST COMPOUND IN CYLINDERS.** Remove spark plugs from cylinder and attempt to turn engine with hand crank to check for excessive fuel or oil in combustion chambers. If engine turns, the lock will be relieved. If the engine does not turn, seizure due to internal damage is indicated. Notify higher authority.

(2) **STARTER INOPERATIVE** (par. 38).

(3) **INCORRECT OIL VISCOSITY.** Drain and refill with proper grade oil (sec. IV).

b. Engine Turns But Will Not Start.

(1) **INOPERATIVE FUEL SYSTEM.** Open shut-off valves in gasoline line at tank and at fuel pump. Remove outlet line at fuel pump. With ignition off, turn engine with starting motor. If free flow of fuel is not evident, fuel is not reaching carburetor (par. 41).

(2) **INOPERATIVE IGNITION SYSTEM.** Remove a cable from spark plug. Hold cable terminal 1/4 inch from cylinder casting. Turn on

GENERATING UNIT M18

ignition switch and crank engine. If spark does not jump the ¼-inch gap, the ignition is inadequate (par. 39).

(3) **SLOW CRANKING SPEED** (par. 38).

c. Engine Does Not Develop Full Power.

(1) **IMPROPER IGNITION** (par. 39).

(2) **ENGINE TEMPERATURE TOO HIGH** (par. 37).

(3) **IMPROPER VALVE CLEARANCE.** Notify higher authority.

(4) **USE OF IMPROPER TYPE OF FUEL.** Drain fuel system and refill with 72 to 80 octane gasoline.

(5) **PREIGNITION.** If the proper octane fuel is being used and the ignition system is functioning satisfactorily, spark plugs of improper heat range may be the cause of the trouble (par. 78); otherwise internal engine trouble would be indicated. Notify higher authority.

(6) **AIR LEAKS AT CARBURETOR OR MANIFOLD FLANGES.** With engine running at approximately 800 rpm, apply a small amount of oil at carburetor gaskets and manifold flanges. If oil is sucked in, there is evidence of a leak. Replace carburetor and throttle body gaskets.

(7) **LOW ENGINE COMPRESSION OR IMPROPER VALVE TIMING.** If engine does not develop full power with fuel reaching combustion chamber, adequate ignition and sufficient oil in engine lubrication system, low compression or improper valve timing would be indicated. Notify higher authority.

(8) **INCORRECT GOVERNOR SETTING.** Disconnect governor linkage rod at throttle body and check for sprung linkage or stuck throttle. If the throttle and linkage operate freely, start engine and accelerate. If speed of 1,200 rpm (indicated by full generator output) is reached, a faulty governor adjustment is indicated. Adjust governor (par. 67 c). **CAUTION:** Do not open throttle valve more than is necessary to determine that the engine will speed up to 1,200 rpm with governor disconnected. Excessive engine speed may damage engine or generator.

d. Engine Misfires.

(1) **FAULTY IGNITION SYSTEM** (par. 39).

(2) **LOW ENGINE COMPRESSION** (subpar. c (7), above).

(3) **INCORRECT CARBURETOR ADJUSTMENT.** Adjust carburetor (par. 65).

(4) **CLOGGED FUEL TANK CAP VENT.** Open vent or replace cap.

(5) **RESTRICTED FUEL FLOW** (par. 41).

(6) **WATER IN FUEL.** Drain fuel system and strain gasoline through a chamois skin or other filter which will not permit water to pass.

e. Excessive Oil Consumption.

(1) **OIL VISCOSITY TOO LOW.** Drain and refill with proper grade oil (par. 17 e (2)).

TROUBLE SHOOTING

(2) **EXTERNAL OIL LEAKS.** Inspect for external leakage at oil line connections.

(3) **PISTON RINGS DAMAGED.** Inspect exhaust for excessive smoke which indicates faulty oil rings. Notify higher authority.

f. Engine Will Not Stop.

(1) **DEFECTIVE IGNITION SWITCH.** Replace ignition switch (par. 39).

(2) **OVERHEATED COMBUSTION CHAMBERS.** Check engine temperature gage for evidence of high temperature. High temperature indicates inadequate cooling (par. 37).

37. COOLING SYSTEM.

a. Engine Overheats.

(1) **LEAKS IN SYSTEM.** Inspect hose connections, radiator, and gaskets for evidence of leakage. Replace faulty parts or notify higher authority. Tighten loose connections.

(2) **RADIATOR DIRTY INSIDE OR OUT.** Drain and flush cooling system (par. 51). Blow dirt from radiator fins with compressed air.

(3) **CLOGGED COOLING SYSTEM.** Flush system. If trouble persists, notify ordnance personnel.

(4) **THERMOSTAT STUCK CLOSED.** Replace thermostat (par. 56).

(5) **WATER PUMP INOPERATIVE.** Drain cooling system. Remove plug from top of water pump. Crank engine by hand and observe impeller action through plug opening. If impeller does not turn, replace pump.

38. STARTING SYSTEM.

a. Starting Motors Will Not Operate.

(1) **BATTERIES RUN DOWN.** Test batteries with hydrometer (par. 27 g). Recharge or replace if discharged.

(2) **STARTER SWITCH INOPERATIVE.** Short circuit terminals on bottom of starter switch. If starting motors operate, a faulty switch is indicated. Replace switch.

(3) **FAULTY WIRING.** If batteries are fully charged and starter switch is operative but current does not reach starting motors, faulty wiring is indicated. Inspect wiring, tighten loose connections, and replace broken wires.

(4) **STARTING MOTORS INOPERATIVE.** Connect positive lead of voltmeter to starting motor terminal, and voltmeter negative lead to ground. Depress starter switch and observe voltmeter reading. If 12-volt reading is obtained and starting motor tested does not function, replace starting motor. Each starting motor can be tested in this manner.

GENERATING UNIT M18

b. Starting Motors Operate and Engage Flywheel, but Will Not Turn Engine.

(1) BATTERIES DISCHARGED. Check batteries with hydrometer (par. 27 g). Recharge or replace if not fully charged.

(2) HYDROSTATIC LOCK IN CYLINDER (par. 36 a (1)).

(3) BENDIX GEAR DAMAGED OR STUCK. Replace or clean Bendix drive.

c. Slow Cranking Speed

(1) HIGH ELECTRICAL EXISTENCE. Visually inspect starting motor and battery circuit to see if any terminals are loose or corroded, or if undersize wires have been installed in circuit. Check operation of starter switch (subpar. a (2), above) and starting motors (subpar. a (4), above).

(2) ENGINE OIL TOO HEAVY. Drain engine oil and fill engine with proper lubricant (sec. IV).

(3) STARTING MOTORS WORN OUT. This condition is indicated by excessive noise during operation of starting motors. Replace worn out starting motors.

39. IGNITION SYSTEM.

a. Engine Fails to Start; Ammeter Shows Pulsating Discharge.

(1) NO SPARK AT SPARK PLUG. Inspect coil to distributor high-tension wire. Connect wire if disconnected and replace if broken.

(2) WEAK SPARK. Clean and adjust distributor points. If spark is still weak, replace condenser. If trouble persists, replace coil.

(3) DISTRIBUTOR CAP CRACKED. Carefully inspect distributor cap. Small cracks, which are often invisible in poor light, are sufficient to cause shorts. Replace distributor cap if cracked.

(4) GROUNDED DISTRIBUTOR ROTOR. Replace rotor.

(5) DEFECTIVE SPARK PLUG CABLES. Visually inspect cables. Replace if defective.

(6) DEFECTIVE SPARK PLUGS. Replace spark plugs.

b. Engine Fails to Start; Ammeter Shows Constant Normal Discharge While Engine is Being Cranked.

(1) DEFECTIVE OR GROUNDED COIL TO DISTRIBUTOR WIRE. Replace wire.

(2) DEFECTIVE BREAKER POINTS. Clean or replace distributor breaker points and readjust breaker point gap.

(3) DEFECTIVE COIL. Replace coil.

(4) DEFECTIVE DISTRIBUTOR. If trouble persists, a defective distributor is indicated. Notify higher authority.

c. Engine Fails to Start; Ammeter Shows No Discharge.

(1) OPEN CIRCUIT IN IGNITION SYSTEM. Remove spark plug wire and hold $\frac{1}{4}$ inch from cylinder head casting. Turn ignition on and hand-crank engine. Absence of spark indicates an open circuit

TROUBLE SHOOTING

in system. Trace two wires from distributor to ignition coil, one wire from ignition coil to terminal block "IGN" terminal, one wire from terminal block "IGN" terminal to ignition switch, and one wire from ignition switch to ammeter. Tighten these connections and replace broken wires. If no open circuit exists in the wiring or connections, a faulty ignition switch condenser or coil is indicated. Replace these assemblies, one by one, until the faulty unit is discovered.

(2) **DISTRIBUTOR FAULTY.** If procedure outlined in step (1), above, failed to eliminate trouble, a faulty distributor is indicated. Notify higher authority.

40. BATTERIES AND GENERATING SYSTEM.

a. Batteries Run Down.

(1) **SWITCHES LEFT ON WHEN NOT IN USE.** Turn switches off when not in use.

(2) **GENERATOR INOPERATIVE.** Start engine and observe charging rate as indicated by battery-charging ammeter on instrument panel. If ammeter shows no charge with engine operating and partially discharged battery installed in unit, faulty wiring or an inoperative generator or voltage regulator is indicated. Check for faulty wiring or a defective fuse in voltage regulator. Replace generator and/or voltage regulator if wiring or fuse is not defective.

(3) **FAULTY BATTERY.** Replace battery. Refer old battery to ordnance personnel for bench testing.

(4) **GROUNDED OR SHORTED CIRCUITS.** Remove discharged batteries. Install fully charged batteries in battery box. Connect grounded wire only. With all switches off, touch positive wire to positive wire post and watch for sparks. If sparks are observed, inspect wiring for damaged insulation. Replace faulty wires. If no sparks are seen, remove 6-volt instrument panel light bulb and turn on 6-volt instrument light switch and repeat test. Presence of sparks for first time on this test indicates trouble is in instrument light circuit. Replace switch to light wire. Failure to locate trouble by above tests indicates the trouble is in the ignition system. Trace wire from ignition switch to "IGN" terminal of terminal block, from terminal block to ignition coil, and from coil to distributor. Replace wires having damaged insulation.

b. Ammeter Does Not Show Charge.

(1) **AMMETER INOPERATIVE.** Turn on 6-volt instrument panel light and ignition switch and observe whether or not ammeter shows discharge. If no discharge is registered, connect a new ammeter temporarily to the leads to the ammeter. If reading is obtained, the ammeter is faulty. If no reading is obtained, test wiring to ammeter for an open circuit.

(2) **LOOSE OR CORRODED CONNECTIONS OR BROKEN WIRES.** Trace

GENERATING UNIT M18

wiring from generator to voltage regulator, to terminal block, to ammeter, to ignition switch, to terminal block, to ignition coil, to distributor. Clean and tighten all connections and repair broken wires in the circuit.

(3) **GENERATOR AND/OR REGULATOR INOPERATIVE.** If condition is not located in above steps, a faulty generator or voltage regulator is indicated. Replace the assembly.

c. Ammeter Shows Excessive Charge.

(1) **VOLTAGE REGULATOR OUT OF ADJUSTMENT.** Refer to higher authority.

d. Ammeter Shows Discharge With Engine Running.

(1) **VOLTAGE REGULATOR OUT OF ADJUSTMENT.** Refer to higher authority.

(2) **GENERATOR INOPERATIVE.** Replace generator.

(3) **SHORTED CIRCUIT** (subpar. a (4), above).

e. Ammeter Shows Heavy Discharge With Engine Stopped.

(1) **SHORTED CIRCUIT** (subpar. a (4), above).

(2) **REGULATOR CIRCUIT BREAKER POINTS STUCK.** Disconnect batteries to stop discharge. Replace voltage regulator.

(3) **AMMETER HAND STICKING OR AMMETER BURNED OUT.** Replace the instrument.

f. Ammeter Hand Fluctuates Rapidly.

(1) **GENERATOR OR REGULATOR FAULTY.** Replace the assembly.

41. FUEL SYSTEM.

a. Fuel Does Not Reach Carburetor.

(1) **LACK OF FUEL.** Check gage on gasoline tank. Replenish fuel supply if depleted.

(2) **SHUT-OFF VALVES IN GASOLINE LINE AT TANK AND/OR AT FUEL PUMP CLOSED.** Turn on fuel valves.

(3) **CLOGGED GAS TANK CAP VENT.** Inspect vent and remove obstruction.

(4) **INOPERATIVE FUEL PUMP, CLOGGED FUEL LINES.** Disconnect carburetor line from fuel pump. Crank engine. If fuel flows from pump, obstruction is in carburetor line. If fuel fails to flow from pump, remove tank line from fuel pump. If fuel flows from tank line, a faulty fuel pump is indicated. Replace pump if faulty. If fuel fails to flow from tank line with both shut-off valves open, an obstructed line is indicated. Remove line and clean obstruction from it.

b. Fuel Does Not Reach Cylinder.

(1) **CARBURETOR CLOGGED.** Replace carburetor and refer original carburetor to authority for repair.

(2) **THROTTLE NOT OPENING.** Disconnect governor linkage rod from throttle body. Start engine and operate throttle manually. This will free throttle if it is stuck. If throttle works satisfactorily,

TROUBLE SHOOTING

defective governor is indicated. Refer to higher authority. CAUTION: Do not allow engine to develop excessive speed while operating throttle manually.

42. ENGINE LUBRICATION SYSTEM.

a. Low or No Oil Pressure.

(1) LACK OF OIL. Check oil on oil gage stick. Replenish oil supply to the "4/4" mark (fig. 10).

(2) LEAKING OIL LINES OR FITTINGS. Visually inspect external oil lines for leaks. Tighten loose connections and replace damaged parts.

(3) OIL PRESSURE GAGE INOPERATIVE. Disconnect gage and temporarily connect oil pressure line to a gage known to function properly. Start engine. Normal functioning of test gage indicates defective gage installed on instrument panel. Replace gage if defective (par. 88 b).

(4) PRESSURE RELIEF VALVE STUCK OR SET TOO LOW. Watch oil pressure gage; turn oil pressure adjusting screw and check for variation of pressure. If no change is evident, defective relief valve is indicated. Notify higher authority.

43. LIGHTING SYSTEM.

a. Instrument Panel 6-volt Light Will Not Burn.

(1) BURNED-OUT FUSE. Pull fuse from clips adjacent to small terminal block on back of instrument panel. Install new fuse.

(2) BURNED-OUT BULB. Remove bulb from socket and test with 6-volt current. Replace bulb if it fails to light.

(3) OPEN CIRCUIT IN WIRING OR SWITCH. Inspect wire "63" from light switch. Replace if damaged; connect if disconnected. Short circuit terminals on rear of switch. If lamp lights, a defective switch is indicated. Replace switch if defective. Trace wiring from switch to "63" terminal of small terminal block, from terminal block to fuse, from fuse to "61" terminal of terminal block, and from terminal block to battery. Clean and tighten dirty or loose connections. Replace broken wires.

b. 6-volt Light Burns Out Continuously.

(1) HIGH RESISTANCE IN BATTERY GROUND CIRCUIT. Inspect battery ground cable; clean and tighten its connections.

(2) GENERATOR REGULATOR OUT OF ADJUSTMENT. Notify higher authority.

44. A-C GENERATING SYSTEM.

a. Voltage Fails to Build Up.

(1) LOOSE CONNECTIONS. Trace circuit from generator, checking and tightening all connections.

(2) ABSENCE OF RESIDUAL MAGNETISM. Lift collector ring brushes for a few moments while generator is running. If voltage

GENERATING UNIT M18

does not then build up, excite field for a moment in proper direction, with exciter brush (commutator brush) raised, using an outside source of current such as a battery.

(3) **REVERSE POLARITY.** This is the same as step a (2), above.

(4) **COLLECTOR RING BRUSHES NOT MAKING PROPER CONTACT.** Clean brushes and brush holders, and increase spring pressure (par. 82).

(5) **OPEN CIRCUIT IN FIELD RHEOSTAT.** Test field rheostat with a test lamp; if no current flows through rheostat, an open circuit is indicated. Replace rheostat.

(6) **BURNED OUT GENERATOR WINDINGS.** Report to higher authority.

b. Excessive Sparking at Exciter Brushes.

(1) **DIRTY OR PITTED COMMUTATOR.** Clean or dress commutator (par. 82).

c. Excessive Sparking at Collector Rings.

(1) **DIRTY OR PITTED COLLECTOR RINGS.** Clean or dress collector rings (par. 82).

d. Excessive Heating of Generator.

(1) **OVERLOADING.** Decrease the load to an allowable limit.

(2) **OPEN OR GROUNDED COILS.** Report to higher authority.

e. Excessive Noise in Generator.

(1) **WORN-OUT BRUSHES.** Inspect brushes and replace if badly worn (par. 82).

(2) **DAMAGED BRUSH SPRINGS.** Inspect brush springs. Report to higher authority if broken or burned.

(3) **COUPLING FAILURE.** Report to higher authority.

(4) **BROKEN BEARINGS.** Report to higher authority.

Section VIII

FRAME

	Paragraph
Description	45
Maintenance	46

45. DESCRIPTION.

a. **Construction.** The base frame is of all-welded steel construction. Seven-inch steel channels, running the length of the unit, are the main members. Bolting holes allow the maximum clearance for proper alinement of the components of the unit.

b. **Functioning.** The frame brings engine, generator, accessories, and canopy together as a complete, self-contained unit to be set upon and affixed to the trailer floor or to the wood skids.

ENGINE

46. MAINTENANCE.

a. Any change of alinement of the frame members, due to shock or undue strain, will be almost certain to throw the generating unit out of alinement, and cause great damage when the unit is put into operation. After any shock to the frame through accident or other cause, frame alinement should be carefully checked.

b. As the frame members are welded together, with no loose parts or accessories, maintenance is merely a matter of inspection to make sure the welds are holding securely, and that shocks have not been severe enough to throw the frame out of alinement.

Section IX

ENGINE

	Paragraph
Description	47
Maintenance	48
Tune-up	49

47. DESCRIPTION.

a. **Construction.** The gasoline engine (figs. 14 and 15) is a 6-cylinder, L-head type, with aluminum pistons. The cylinder block and crankcase are cast in one piece, and the water jacket extends the full length of the cylinder bore. The cylinder head is made of cast iron, and is easily removable to permit service operations.

b. **Accessories.**

(1) **WATER PUMP.** The water pump is attached to the left side of the engine block on the accessory drive (fig. 14).

(2) **FUEL PUMP.** The fuel pump is on the right side of the engine, back of the exhaust pipe (fig. 15).

(3) **MANIFOLD.** The combination exhaust and intake manifold is on the right side of the engine block (fig. 15).

(4) **MUFFLER.** The muffler is strapped to the frame at the right of the engine (fig. 15).

(5) **OIL FILTER.** The oil filter is on the left side of the engine, above the accessory drive (fig. 14).

(6) **THERMOSTAT.** The thermostat is in the water outlet line to the radiator on top of the engine (fig. 24).

(7) **THROTTLE BODY.** The throttle body is mounted on the intake section of the manifold at right of engine (fig. 15).

(8) **CARBURETOR.** The carburetor is mounted on the throttle body at right of engine (fig. 15).

(9) **AIR CLEANER.** The air cleaner is mounted on a bracket welded to the canopy frame right center upright member. It is

GENERATING UNIT M18

RA PD 78102

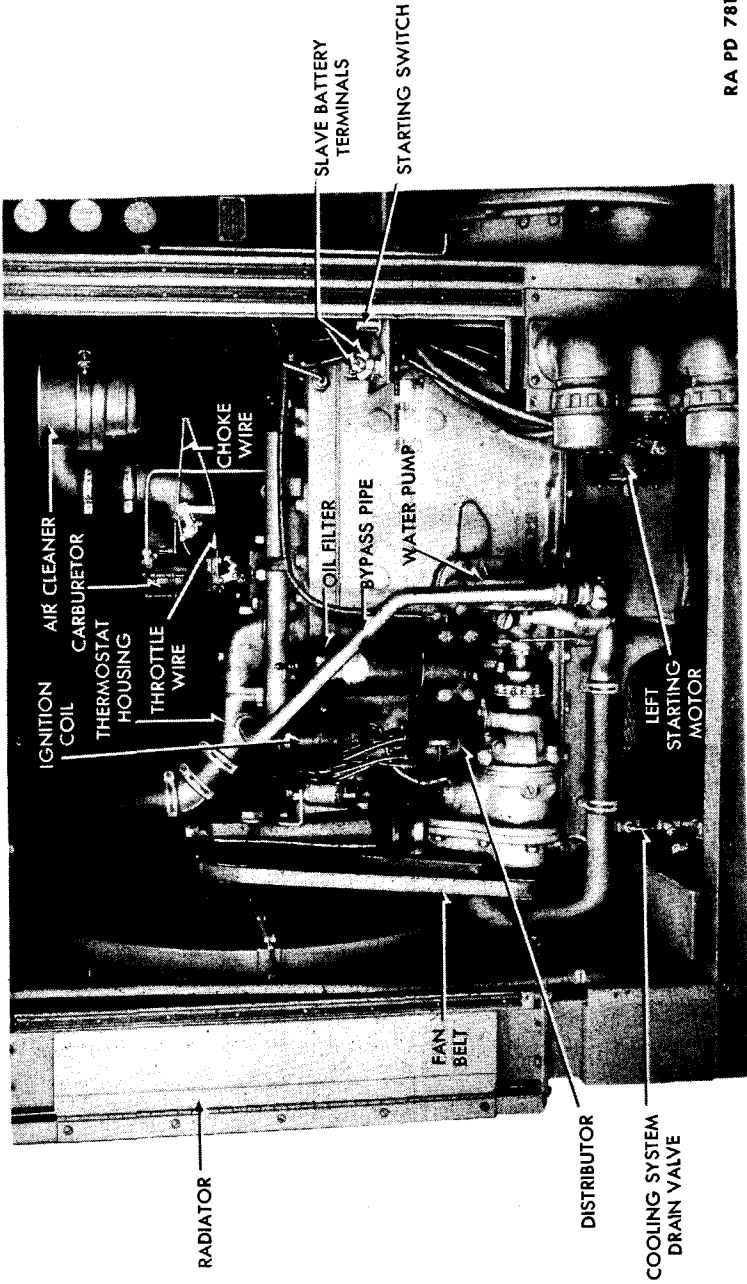

Figure 14 — Engine — Left Side

ENGINE

- A—AIR CLEANER
- B—CARBURETOR ELBOW
- C—CARBURETOR
- D—MANIFOLDS
- E—THROTTLE BODY
- F—GENERATOR
- G—GOVERNOR LINKAGE ROD
- H—FAN BRACKET
- J—GOVERNOR
- K—TWO-CHARGE REGULATOR
- L—MUFFLER
- M—RIGHT STARTING MOTOR
- N—EXHAUST TUBE
- P—FUEL PUMP
- Q—PIPE CLAMP
- R—FLEXIBLE EXHAUST PIPE

RA PD 78106

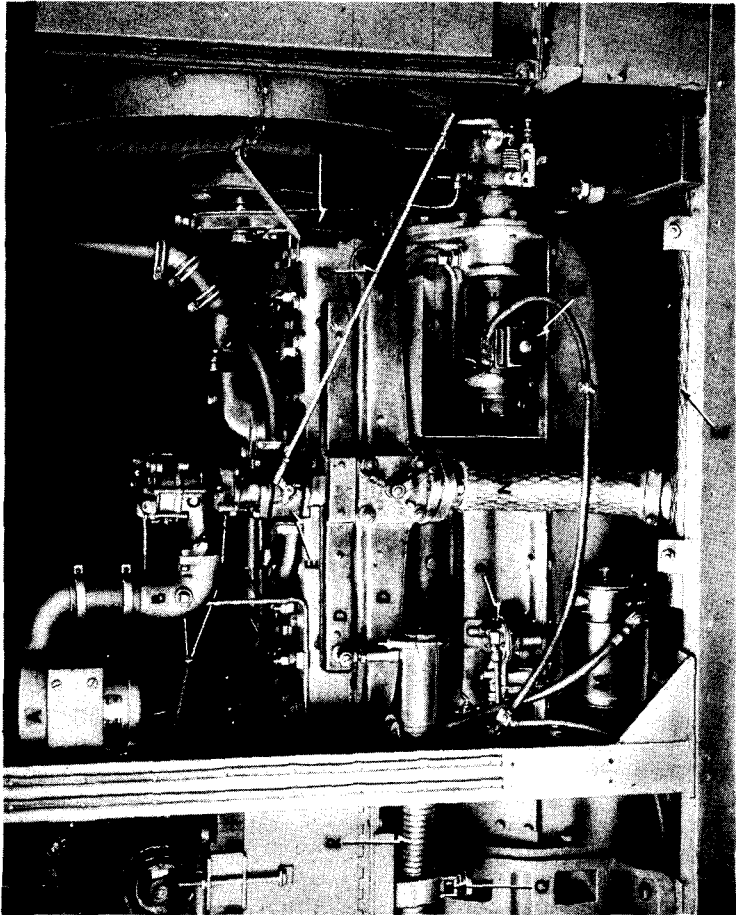

Figure 15 — Engine — Right Side

GENERATING UNIT M18

attached to the carburetor elbow by a hose connection (figs. 14 and 15).

(10) **BATTERY-CHARGING GENERATOR.** The battery-charging generator is located under the manifold at the right side of engine (fig. 15).

(11) **GOVERNOR.** The governor is at the right side of the engine, in front of the battery-charging generator (fig. 15).

(12) **DISTRIBUTOR.** The distributor is mounted on the accessory drive housing on the left side of engine (fig. 14).

(13) **IGNITION COIL.** The ignition coil is mounted on a bracket held down by engine cylinder head cap screws on the left side of engine (fig. 14).

(14) **STARTING MOTORS.** Two starting motors are used, one on each side of the engine block mounted on the engine bell housing (figs. 14 and 15).

c. Functioning. The engine is of the internal combustion, 4-stroke cycle, automotive type. Fuel is drawn into the fuel pump from the fuel tank, and then forced through to the carburetor to be mixed with the right quantity of air. The mixture goes into the intake section of the manifold, where it is drawn into each cylinder at the proper time by the down, or intake stroke of the piston. It is then compressed by the upward, or compression stroke, and ignited by a spark as the piston reaches the top point of travel. The expansion of the burning gases forces the piston down for the power stroke. Before the piston reaches bottom, the exhaust valve opens, and as the piston returns in the exhaust stroke, it forces the burned gases through, into the exhaust section of the manifold, and out by way of the muffler. The complete cycle of four piston strokes results in two revolutions of the crankshaft. Successive firing in the six cylinders results in a steady impelling force on the crankshaft.

d. Specifications.

Make	Hercules gasoline
Model	WXLC-3
Type	L-head
Number of cylinders	6
Bore	4¼ in.
Stroke	4¾ in.
Piston displacement	404 cu in.
Compression ratio	6.35 to 1
Firing order	1-5-3-6-2-4
Maximum horsepower at rated speed	67 hp at 1,200 rpm
Crankcase capacity	7 qt
Cooling system capacity	36 qt
Weight (with accessories) (approx.)	945 lb

ENGINE

48. MAINTENANCE.

a. **Inspection and Adjustments.** Section III covers general inspections which include the engine. In section VII are given specific checks for various sorts of engine faults. Paragraph 49 deals with procedure for engine tune-up.

49. TUNE-UP.

a. Procedure.

(1) One of the most important operations in the maintenance of the engine is proper engine tune-up. This operation, more than any other, determines whether or not the engine delivers the maximum in performance and economy. Only by accurately making the following checks and adjustments can the maximum performance of the engine be obtained.

(2) COMPRESSION.

(a) Before making any checks on the engine, it should be run for several minutes to warm it up, and lubricate the valve mechanism. The compression of the engine should be checked first when tuning, because an engine with uneven compression cannot be turned successfully.

(b) Remove all spark plugs. The ignition should be turned off, with the governor throttle valve in the "OPEN" position.

(c) Insert the compression gage in a spark plug hole, and hold it tightly. Crank the engine with the starting motor until the gage reaches its highest reading, which requires only a few turns. Repeat the same test on all cylinders, and make a note of the compression on each.

(d) The compression on all cylinders should be 110 pounds per square inch or better, and all cylinders should read approximately the same, within 5 to 10 pounds, for satisfactory engine performance.

(e) Should one or more cylinders register low compression readings, notify ordnance maintenance, as a mechanical defect has developed beyond the using arms scope of repair.

(3) **SPARK PLUGS.** Remove, clean, and adjust all spark plugs (par. 78).

(4) BATTERY TEST.

(a) Connect the negative terminal of a voltmeter to the starting switch terminal, and the positive terminal of the voltmeter to a good ground.

(b) Rotate the engine with the starting motors for 15 seconds. If the starting motors turn the engine over at a good rate of speed with the voltmeter reading 10 volts or better, it indicates a satisfactory starting circuit, which includes the condition of the battery, terminals, and cables; however, if it turns over slowly, or the voltmeter reading is under 10 volts, the starting motors, battery, and battery cable terminals should be checked individually to locate the source of the trouble (sec. XIV).

GENERATING UNIT M18

(5) DISTRIBUTOR.

(a) Remove the spark plug wires from the distributor cap, and examine the terminals for corrosion. The wires should also be checked for damaged insulation and for being oil-soaked.

(b) Remove the distributor cap, and check the cap and distributor rotor for cracks or burned contacts.

(c) Check the automatic advance mechanism, by turning the distributor cam in a clockwise direction as far as possible, and releasing the cam to see if the springs return it to its retarded position. If the cam does not return readily, report to ordnance personnel.

(d) Examine the distributor points. Dirty points should be cleaned, and pitted or worn points should be replaced. Check the points for alignment, and align them, if necessary.

(e) Hand-crank the engine until cam follower rests on a peak of the cam. Adjust the point gap to between 0.019 and 0.021 inch, using feeler gage. This operation must be performed very accurately. Hand-crank engine until the cam follower is located between the cam peaks. Hook the end of a point scale over the movable point, and pull steadily on the spring scale until the points just start to open. Correct spring tension is between 18 and 21 ounces.

(f) Install distributor cap and spark plug wires. Make sure that the terminals of the primary wire from the ignition coil to the distributor are clean and tight.

(6) FUEL PUMP. Remove the sediment cup and screen and wash them thoroughly in SOLVENT, dry-cleaning. When assembling, make sure that the cork gasket is in good condition, and properly seated. Tighten all fuel pump connections.

(7) AIR CLEANER.

(a) Remove the air cleaner cup, deflector, and element from the under side of the air cleaner.

(b) Empty the oil out of the cup and clean out all oil and accumulated dirt. Wash filter element by slushing up and down in SOLVENT, dry-cleaning. Dry thoroughly, either with an air hose or by letting it stand until dry. Fill the cup to level indicated on deflector with OIL, engine (seasonal grade).

(c) Install the cup, deflector, and filter element onto the cleaner body.

(8) CARBURETOR. The only carburetor adjustment that should be attempted by the using arms is with the idling speed mixture adjusting screw. This controls the fuel mixture to the engine while the engine is operating at idling speed only (fig. 37).

(9) IGNITION TIMING. NOTE: Timing should be checked under the supervision of ordnance personnel. Attach one wire of the neon timing light to No. 1 spark plug, and the other wire to the No. 1 spark plug wire. Start the engine and run it at idling speed. Loosen distributor clamp and slightly rotate distributor body clockwise or

COOLING SYSTEM

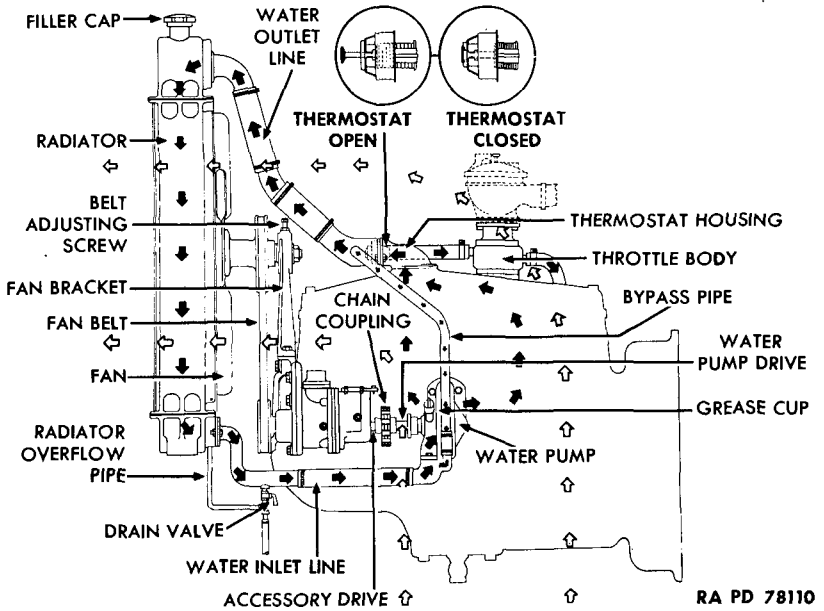

Figure 16 – Cooling System Diagram – Black Arrows Show Water Circulation; White Arrows Show Air Circulation

counterclockwise until the entire white dot on the flywheel is visible through the timing hole in the flywheel housing each time the light goes on.

(10) **COOLING SYSTEM.** Tighten all hose connections, and examine for any indications of water leaks. Check the fan and exciter belts for cracks, oil-soaking, and for proper tension.

Section X

COOLING SYSTEM

	Paragraph
Description	50
Cleaning	51
Radiator	52
Fan	53
Fan belt	54
Water pump	55
Thermostat	56

50. DESCRIPTION (fig. 16).

a. Construction. The water-cooling system consists of the radiator (fig. 18), thermostat (fig. 24), fan assembly, centrifugal

GENERATING UNIT M18

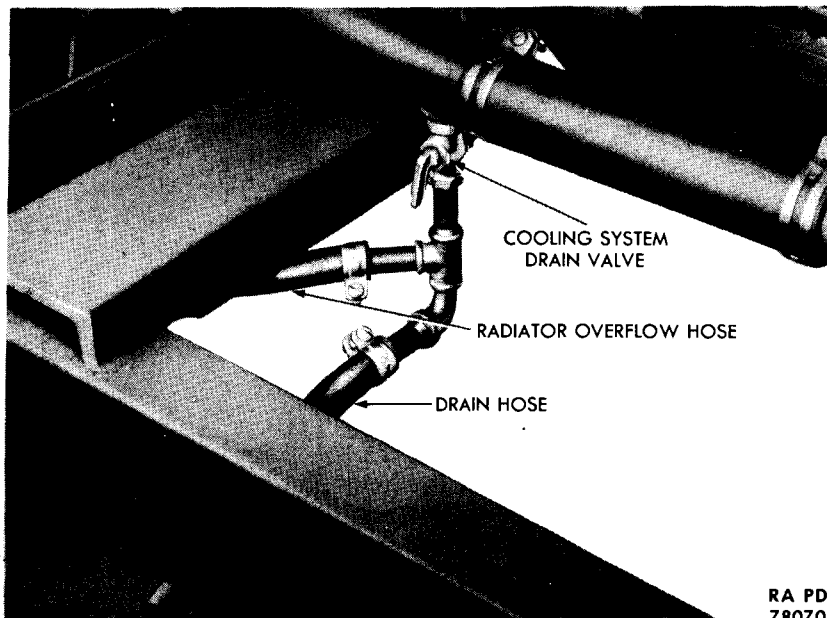

Figure 17 – Cooling System Drain

water pump, and the connecting lines and hose. The water capacity is 36 quarts. The system may be drained by opening a drain valve located in the water outlet pipe connected to the bottom of the radiator (fig. 17). The fill cap is in the usual position at the top of the radiator.

b. Functioning. The pump circulates cooled water from the bottom of the radiator through the channels in the water jacket and cylinder head. The water heated in the water jacket is forced through the radiator inlet into the upper radiator tank, flows down the radiator tubes for cooling, and is redrawn into the pump to complete the cycle. Air, drawn through louvers in engine and generator panels, passes across the engine, and is forced out of the unit through the radiator fins by the action of the fan, thereby cooling the water. On the top of the engine, at the point where the water returns to the radiator, is a thermostat whose function is to keep cool water from entering the radiator, by forcing it to return directly to the pump through the bypass tube until the engine is warmed up.

51. CLEANING.

a. General. The cooling system should be cleaned at least twice a year. It should be cleaned before the COMPOUND, antifreeze (ethylene glycol type), is put into the system, and again after it is removed. If the cooling system is very dirty or clogged, so that over-

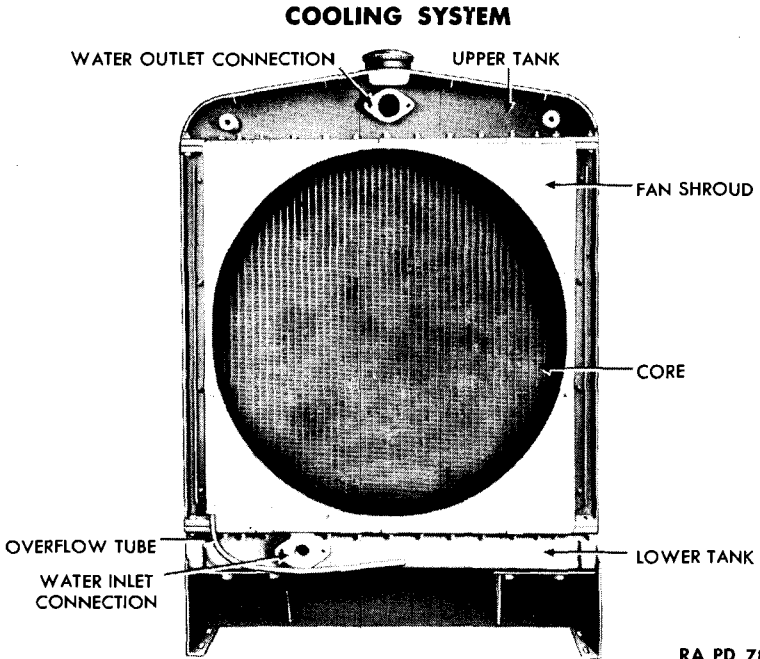

Figure 18 – Radiator and Support – Rear View

heating occurs, ordnance personnel should be notified. The entire system should be examined for leaks both before and after cleaning and flushing. The cleaning solution should never be mixed with anti-freeze solutions or inhibitors.

b. Cleaning.

(1) Run the engine until the temperature is within operating range. Stop the engine, remove the radiator cap, and drain the system by opening the drain valve. If necessary, use a wire to keep the drain hole open if it tends to become clogged. Coolants containing ethylene glycol must be saved or discarded as outlined in W.D. Circular 137, V, dated 16 June 1943.

(2) Allow the engine to cool. Close the drain valve, start the engine at idling speed, and start immediately to pour water slowly into the radiator, until it is nearly full. Add the COMPOUND, cleaning (federal stock No. 51-C-1568-500), in the proportion of one container of cleaner to every four gallons of cooling system capacity. Then fill the system with water. Never mix the water and the cleaning compound before putting them into the system.

(3) Place a clean drain pan to collect overflow, and use it to maintain the level in the radiator when necessary.

(4) Replace the radiator cap and run the engine at moderate speed, covering the radiator if necessary, until the coolant reaches a tempera-

GENERATING UNIT M18

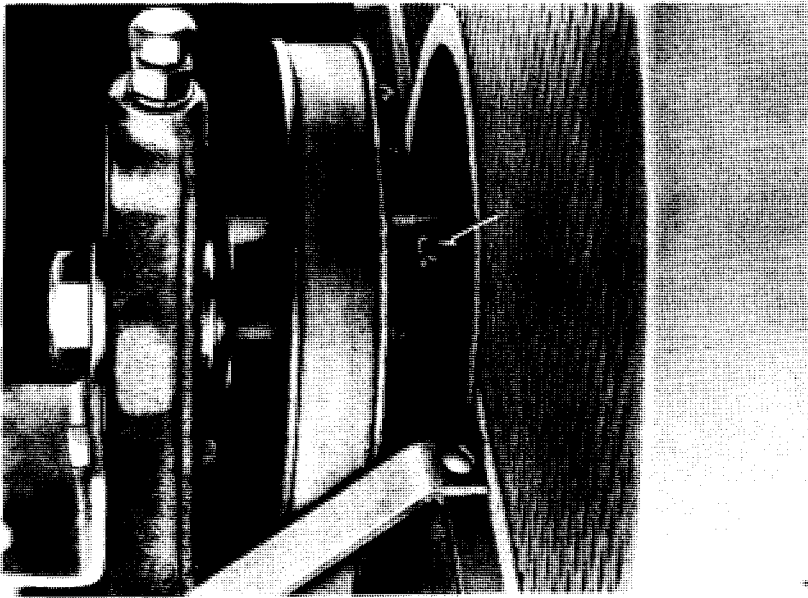

RA PD 78080

Figure 19 – Fan Hub Lubrication Plug

ture above 180 F but not over 200 F. Do not allow the level in the radiator to drop low enough to interfere with the circulation.

(5) Stop the engine after it has run for 30 minutes within the 180-F to 200-F range; then, remove the radiator cap, and drain the system completely.

c. Neutralizing.

(1) Allow the engine to cool. Close the drain valve, run the engine at idling speed, and commence immediately to pour water slowly into the radiator. Pour until it is nearly full. Add the neutralizer compound (federal stock No. 51-C-1568-500) in the proportion of one container of neutralizer to every 4 gallons of cooling system capacity. Then fill the system with water.

(2) With the radiator covered, run the engine for at least 5 minutes at operating temperature. Then stop the engine.

(3) Drain the system completely by removing the radiator cap and opening the drain valve (fig. 17).

d. Flushing.

(1) Allow the engine to cool. Close the drain valve, start the engine, and fill the system with water immediately.

(2) Run the engine until the coolant is heated to operating temperature.

(3) Drain the system by removing the radiator cap and opening the drain valve. Repeat the flushing operation until the drain water is clean.

COOLING SYSTEM

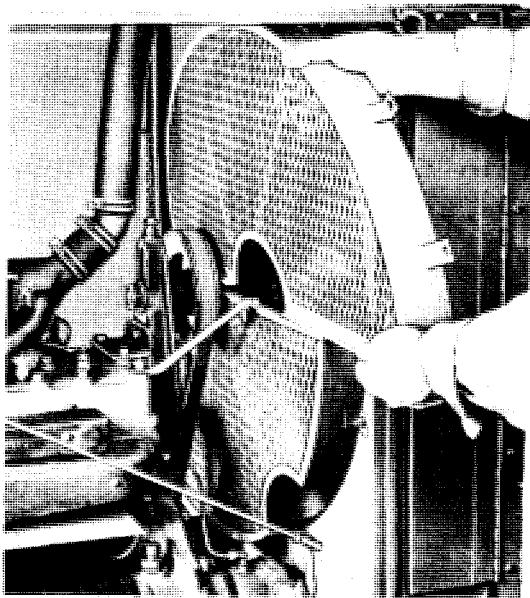

RA PD 78085

Figure 20 – Fan Guard Removal

(4) Clean all sediment from the radiator cap, valve, and the overflow pipe. Blow insects and dirt from radiator core air passage with compressed air, blowing from the rear. Use water, if necessary, to soften obstructions.

e. Leaks. After completing flushing operation and before pouring appropriate coolant into cooling system, allow engine to cool. Start the engine, and immediately fill the system with coolant. Stop the engine when the cooling system is completely full; then examine the entire cooling system for leaks. The cleaning solution often uncovers leaks which already exist but are plugged with rust or corrosion.

f. Coolant Service.

(1) When servicing the vehicle for summer, nearly fill the system with clean water. Add COMPOUND, inhibitor, corrosion (federal stock No. 51-C-1600) in the proportion of one container of inhibitor to each 4 gallons of cooling system capacity. Then fill the system with water.

(2) When servicing for winter, fill the system about one-quarter full of clean water. Add sufficient COMPOUND, antifreeze (ethylene glycol type), for protection against the lowest temperature likely to be encountered. Nearly fill the system with water, and run the engine until normal operating temperature is reached; then add sufficient water to fill the system to the proper height.

GENERATING UNIT M18

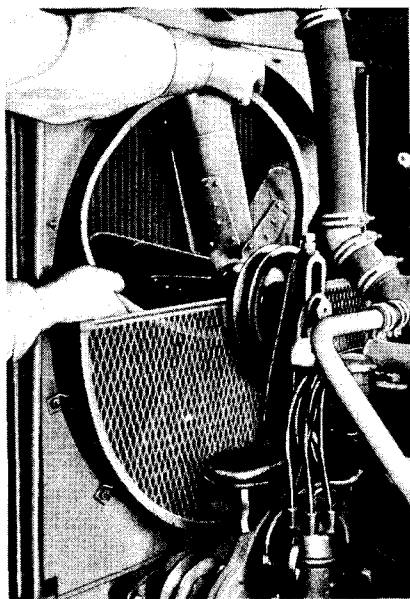

RA PD 78086

Figure 21 — Fan Belt Installation

52. RADIATOR (fig. 18).

a. **Description.** The radiator is of the 3-piece, heavy-duty tractor type, and is mounted on the frame in front of the engine where it acts as front support for the canopy roof.

b. **Maintenance.** Radiator and all connections should be frequently inspected for leaks.

53. FAN.

a. **Description.** The fan assembly is made up of the fan, the fan shaft, a pulley, and an adjustable mounting bracket. The fan belt is $1\frac{5}{16}$ inch wide, and 54 inches long.

b. **Maintenance.** The fan does not need special attention. Fan mounting bracket screws must be kept tight, and the whole assembly kept clean and properly lubricated (fig. 19).

c. **Removal.**

(1) Loosen lock nut on fan mounting bracket screw. Turn screw until fan belt is loose. Slip belt off top pulley.

(2) Take out screws, nuts, and lock washers holding the two sections of the fan guard together. Bend cylinder head to guard bracket back enough to clear guard. Take off nuts and lock washers attaching the upper guard section to the shroud, and lift out guard (fig. 20).

(3) Take out fan bracket base cap screws and lock washers holding fan bracket to engine, and lift off fan assembly.

COOLING SYSTEM

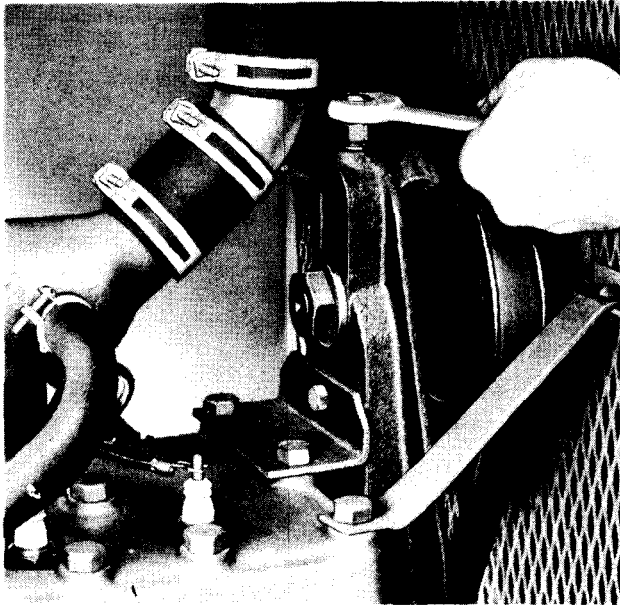

RA PD 78083

Figure 22 – Fan Belt Adjustment

d. Installation.

(1) Attach fan bracket to engine with cap screws provided.

(2) Bring fan belt up over fan onto fan pulley (fig. 21), then onto pulley at end of accessory drive. Turn adjusting screw (fig. 22) until the amount the fan belt can be deflected at a center point between pulleys measures from $\frac{1}{2}$ to $\frac{3}{4}$ inch. Tighten lock nut against bracket.

(3) Place fan guard sections in position, and secure to fan shroud with lock washers and nuts on the projecting bolts. Fasten sections together with machine screws, lock washers, and square nuts. Bend cylinder head to guard bracket into position so that its screw hole is alined with screw holes third from right-hand side of the two half sections of the guard.

54. FAN BELT.

a. General. For best results, the fan belt should be kept free of dirt, grease, and oil. Its adjustment should be checked frequently. Fan belt is properly adjusted when it can be deflected from $\frac{1}{2}$ to $\frac{3}{4}$ inch at a center point between pulleys.

b. Removal.

(1) Remove fan belt from pulley (par. 53 c).

(2) Remove upper half of fan guard (par. 53 e).

(3) Take fan belt off lower pulley, and remove it by bringing it down over fan (fig. 21).

GENERATING UNIT M18

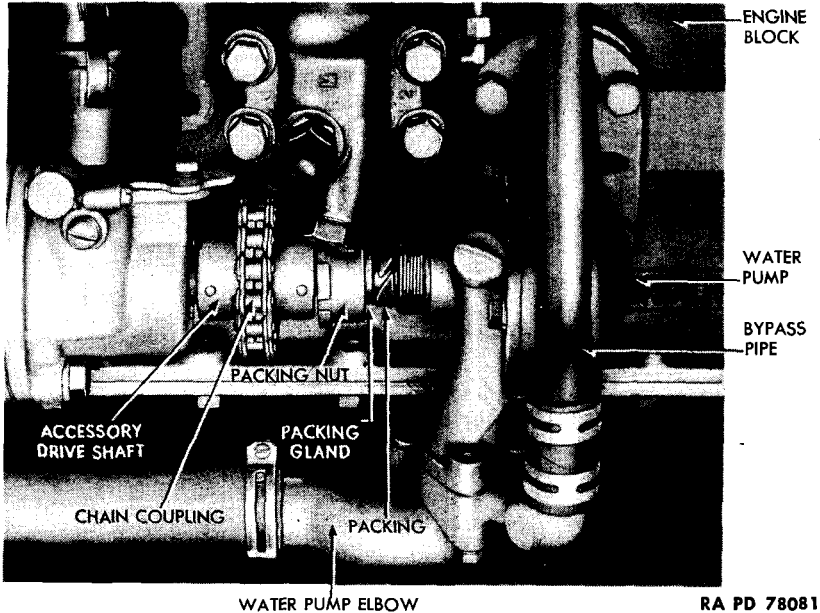

RA PD 78081

Figure 23 – Water Pump Packing Installation

c. **Installation.** For instructions on installing fan belt, see paragraph 53 c.

55. WATER PUMP.

a. **Construction.** The centrifugal water pump is mounted on the left side of the engine. It is driven by the accessory drive to which it is attached by a chain coupling. Four packing rings (split-ring type), tightened by a packing nut against a gland, seal the water pump at the shaft end.

b. **Functioning.** The impelling force of the water pump circulates the cooled water from the bottom of the radiator through the entire cooling system (fig. 16).

c. **Maintenance.** The water pump should be lubricated as specified in section IV. A leak developing at the water pump packing nut can be stopped by tightening the nut; however, care must be taken not to tighten the nut with considerable force. Water pump must be repacked if packing nut is turned up its full thread and leaking continues. New packing will not stop the leak at the shaft if the shaft is worn. The pump must be replaced. Any other trouble with the water pump necessitates replacement of the complete unit.

d. Repacking (fig. 23).

- (1) Drain cooling system.
- (2) Unscrew packing nut, pry out packing gland, and remove old

COOLING SYSTEM

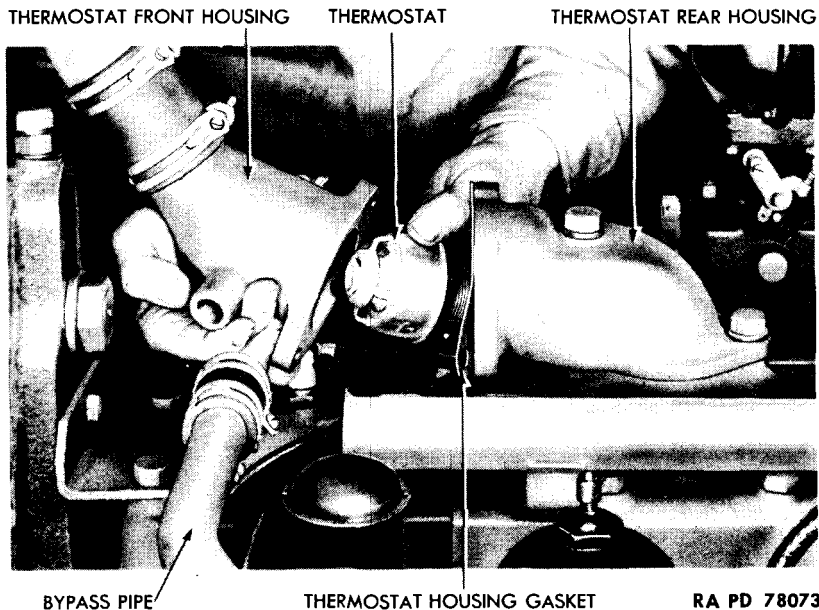

Figure 24 – Thermostat Removal

packing. The four packing rings are removed by prying them out of the housing.

(3) Place a new split-ring packing on the shaft and, using the packing gland, push it into the pump housing. Continue this procedure until four packing rings are inserted in the pump housing.

(4) Push packing gland into position over packing in pump housing, and screw packing nut over gland onto pump body. Do not tighten nut with any considerable force.

(5) Refill cooling system, start engine, and check for a leak at the pump. If a leak exists, tighten packing nut while engine is running.

e. Removal.

(1) Drain cooling system (fig. 17).

(2) Loosen clamp screw holding hose section to water pump elbow. Take out cap screws fitting water pump elbow to water pump. Remove elbow.

(3) Loosen clamp screws holding top and bottom hose sections to bypass pipe, and remove pipe.

(4) Separate coupling chain attaching pump drive to accessory drive by forcing out removable link.

(5) Take out cap screws and lock washers holding water pump and gasket to engine block. Lift pump and gasket from engine.

f. Installation.

(1) Attach pump and gasket in position on side of engine block with the three cap screws and lock washers provided.

GENERATING UNIT M18

(2) Bring coupling chain around coupling sections, and lock in place by inserting removable link.

(3) Connect top of bypass pipe to thermostat housing with the rubber hose. Tighten clamp screws, connect bottom of bypass pipe to the water pump connection by the hose section, and tighten clamp screws.

(4) Insert pipe end of water pump elbow in rubber hose in bottom water line. Bring flanged end to water pump, and install cap screws and lock washers provided. Tighten clamp screw holding hose to pipe.

56. THERMOSTAT (fig. 24).

a. Construction. The thermostat is a plug-type, temperature-relief fitting, set in a split elbow housing in the upper radiator line to the engine.

b. Functioning. Until the water in the engine reaches a temperature of 150 F, the thermostat keeps this water from circulating through the radiator, thus decreasing the "warming up" period. At 150 F, the thermostat begins to open; at 180 F it is fully open. While the thermostat is closed, the water circulated through the engine by the pump is shunted off through the bypass line back to the pump.

c. Removal.

(1) Open cooling system drain valve (fig. 17). This will drain engine, radiator, and water lines.

(2) Loosen screws on clamps holding hose to thermostat housing, and disconnect bypass pipe from housing.

(3) Take out the cap screws and lock washers through the flanges of the thermostat housing, and separate the housing. The thermostat may now be removed from the housing (fig. 24).

d. Maintenance. The thermostat is entirely enclosed, and ordinarily needs no attention. To find out if the thermostat is functioning properly, place it with a thermometer in a pan of water, and begin to heat the water. The thermostat should begin to open when the thermometer indicates 150 F, and should be fully opened at 180 F.

e. Installation.

(1) Insert thermostat in the half of thermostat housing closest to the radiator, in the flanged end, with the coil showing.

(2) Bring flanged ends of housing halves together, first putting gasket in place. Bolt together with cap screws and lock washers. Tighten bolt on strap holding hose to thermostat housing. Bring hose at end of bypass line over nipple on thermostat housing, and tighten clamp bolt.

Section XI
EXHAUST SYSTEM

	Paragraph
Description	57
Manifold	58
Exhaust tube	59
Muffler	60
Flexible exhaust pipe	61

57. DESCRIPTION.

a. Construction. The exhaust system (fig. 25) is made up of the exhaust section of the manifold, the tube connection between muffler and manifold, the muffler (fig. 29), and the flexible tube that is attached to the outside end of the muffler when the unit is in operation.

b. Functioning. The burned gases resulting from the ignition of the mixture of gasoline and air in the cylinders are forced by the exhaust stroke of the pistons out of the cylinders, into the manifold, and away from the unit by way of the exhaust pipe, the muffler, and the exhaust tube.

58. MANIFOLD.

a. Description. The intake and exhaust manifold, along the right-hand side of the engine block, is of 1-piece construction. The top section is the intake, where the mixture of gasoline and air enters the cylinders. Pre-heating of the mixture is accomplished by an opening that allows the hot exhaust gases to strike the intake manifold wall. The size of this opening can be adjusted by a lever on the face of the manifold (fig. 26). A spring holds this lever in its correct position, and the setting should not be changed except by permission of higher authority. A crankcase ventilator tube leads from the rear valve chamber cover to the intake manifold. A check valve between the end of the tube and the intake manifold prevents operation of the tube before a sufficient amount of intake manifold suction is built up. During engine operation, crankcase ventilation is provided by passage of air from the atmosphere, through the crankcase breather, crankcase, crankcase ventilator tube, and into the intake manifold.

b. Maintenance. The manifold should be frequently inspected for cracks. When engine troubles develop that might have been caused by manifold cracks which are not apparent, the manifold should be taken off and thoroughly inspected. Check bolts for tightness. Check collar gasket. When replacing, use new gasket. Thoroughly scrape off old gasket.

c. Removal.

(1) Take out cap screws holding asbestos lined charging generator guard in place, and remove guard (fig. 53).

GENERATING UNIT M18

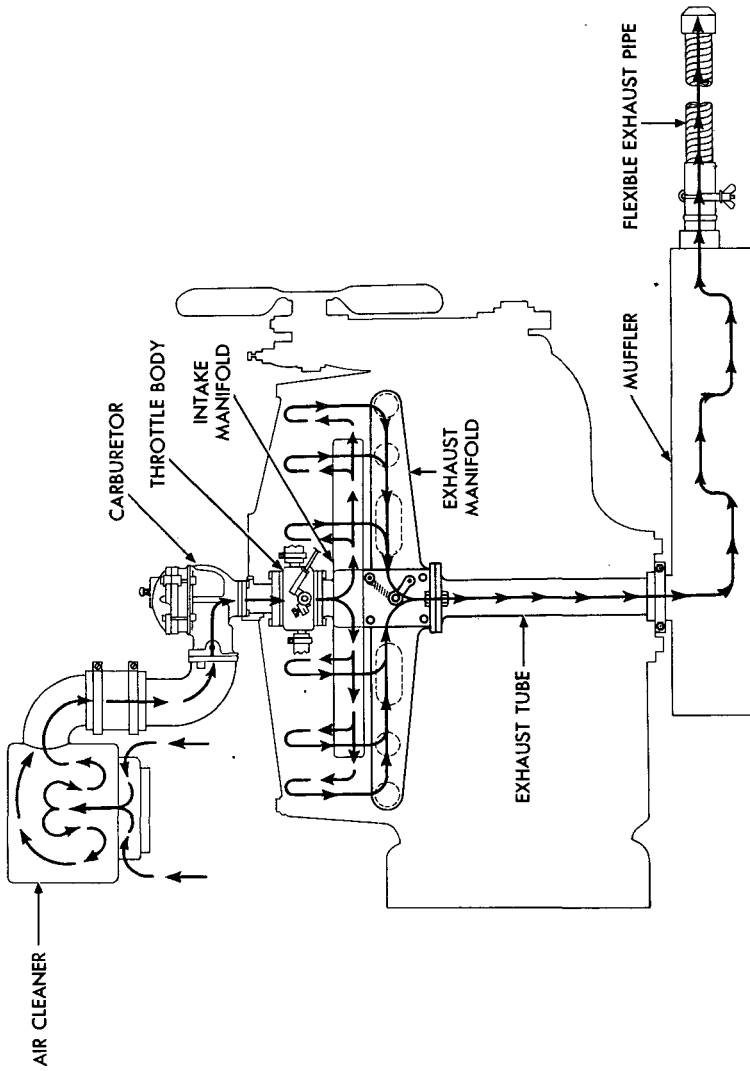

RA PD 78094

Figure 25 — Intake and Exhaust System Diagram (Broken Arrows, Intake Air — Solid Arrows, Exhaust Gas)

EXHAUST SYSTEM

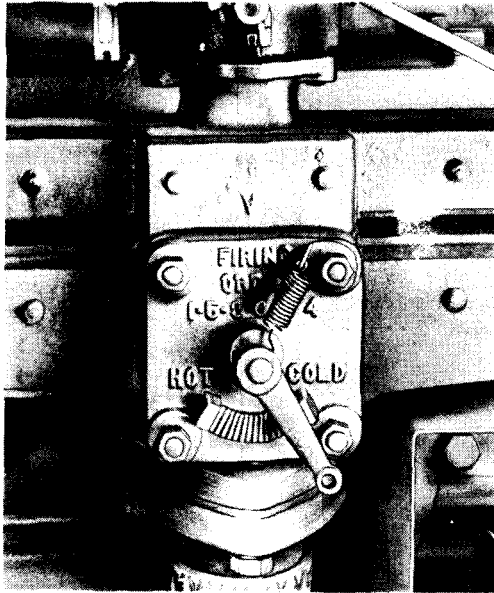

RA PD 78054

Figure 26 – Manifold Lever and Holding Spring

(2) Disconnect sleeve ferrule nut which attaches crankcase ventilator tube to check valve on manifold.

(3) Take off nut fastening governor linkage rod to throttle valve arm. Separate rod from arm (fig. 42).

(4) Remove the two cap screws and lock washers which attach carburetor elbow to carburetor (fig. 38). Take out the two stud nuts and lock washers which hold the throttle box to the manifold flange, and remove carburetor and throttle box (fig. 38).

(5) Take out the three cap screws and lock washers holding together the two lower manifold flanges. Loosen lock bolt through manifold flange. This loosens exhaust tube from manifold (fig. 46).

(6) Take the nuts from the 10 studs that hold the manifold to the engine block, and remove manifold and gaskets (fig. 27).

d. Installation.

(1) Bring manifold, with new gaskets affixed, into position against the engine wall with the engine studs in place through the manifold slots. Bring the lower flange or collar of the manifold down over the exhaust pipe. Make sure the pipe reaches up into the top flange. Tighten the bolts that attach the flanges together with the ring gasket (fig. 28) set between. Tighten lock bolt through the upper flange. Place lock washers on the manifold attaching studs and secure manifold in position with 10 hexagonal nuts.

(2) Bring assembly of carburetor and throttle box down in place

GENERATING UNIT M18

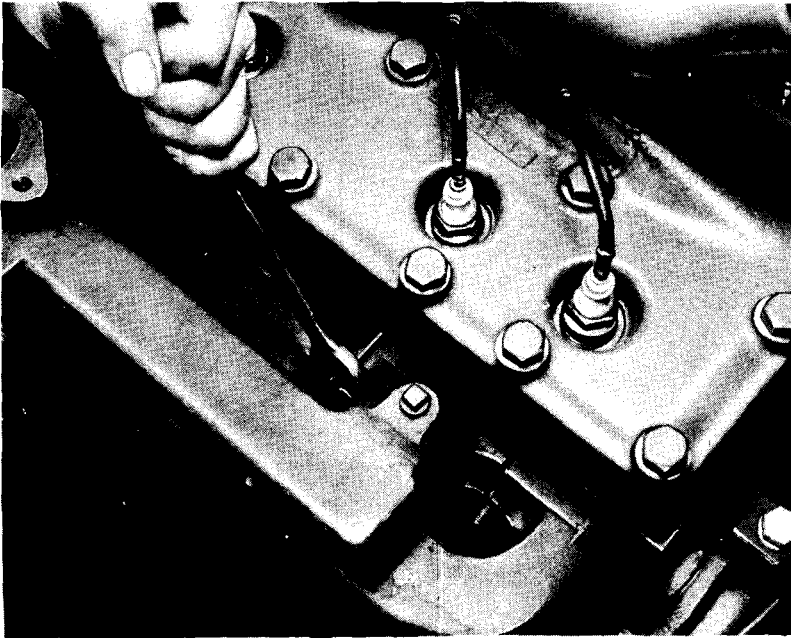

RA PD 56927

Figure 27 – Manifold Removal

on the manifold flange, with new gasket between. Attach with the two cap screws holding throttle box to manifold flange. Position a new gasket between air intake elbow and carburetor. Install the two cap screws and lock washers which attach carburetor air intake elbow to carburetor (fig. 38).

(3) Tightly screw sleeve ferrule nut, on crankcase ventilator tube, onto check valve on manifold.

(4) Bring governor linkage rod to throttle valve arm, and attach nut, coupling them together (fig. 42).

(5) Position battery charging generator guard, and install cap screws holding it in place (fig. 53).

59. EXHAUST TUBE.

a. Description. An insulated exhaust tube (fig. 29) carries the exhaust gases from manifold to exhaust muffler. One end of this pipe fits through the manifold companion flange, through a ring gasket, and into the manifold lower flange. A horizontal hexagonal-head set screw through the manifold flange holds the tube firmly in place. The companion flange bolts to the manifold flange. The tube fits into the muffler through a collar provided with a tightening strap that holds the two securely together. The pipe is covered with woven asbestos sheeting, held in place by metal straps.

EXHAUST SYSTEM

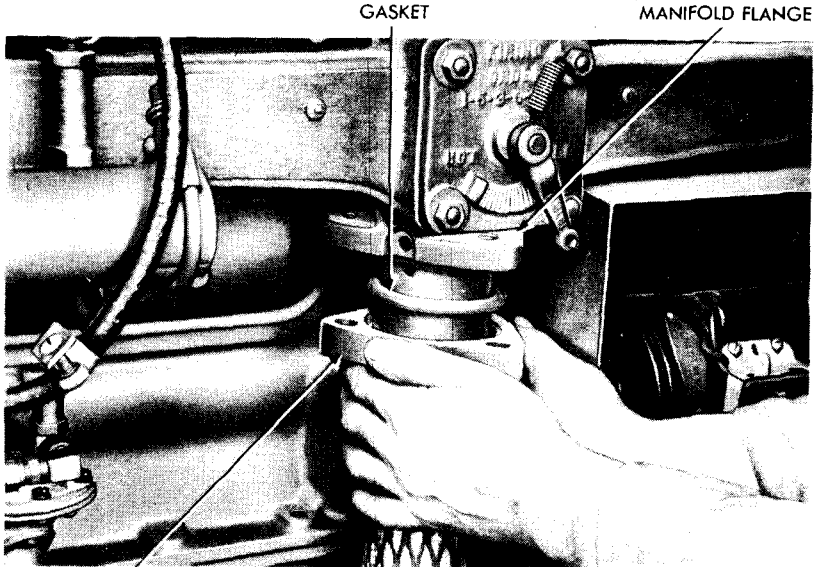

MANIFOLD COMPANION FLANGE

RA PD 78091

Figure 28 — Manifold Flange Gasket Installation

b. Maintenance. Examine exhaust tube regularly for cracks. Take particular note of welded joints. Test regularly for tightness of connections with muffler and manifold.

c. Removal (fig. 29).

(1) Remove right-hand starting motor (par. 79 d).

(2) Remove manifold companion flange cap screws. Remove manifold exhaust tube retaining screw. Remove exhaust tube from manifold flanges. If exhaust tube will not come free from manifold, the next operation will automatically release it.

(3) Unscrew nuts at both ends of muffler strap screws, and remove straps, muffler, and exhaust tube assembly.

(4) Loosen the two nuts on U-bolt which clamp lower end of exhaust tube to muffler. Pull muffler from tube.

d. Installation (fig. 29).

(1) Position U-bolt around split flange on muffler. Position lower end of exhaust tube in split flange and tighten nuts on U-bolt.

(2) Position muffler and exhaust tube assembly in unit. Be sure upper end of exhaust tube fits up into manifold flange. Install exhaust tube retaining screw. Position companion flange on manifold flange and install the three manifold companion flange cap screws.

(3) Insert ends of muffler strap screws through screw holes in muffler brackets which are welded to frame. Install both strap screw nuts.

(4) Install starting motor (par. 79 e).

GENERATING UNIT M18

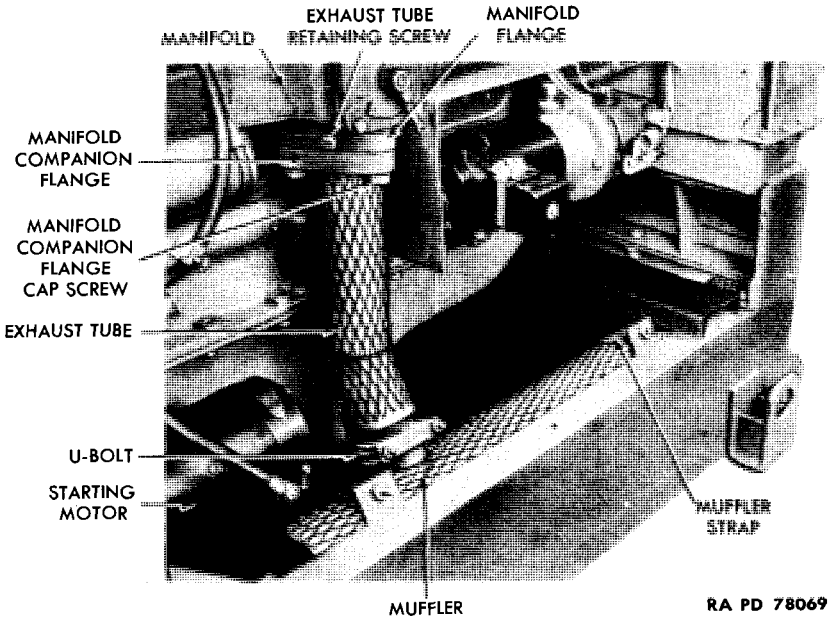

RA PD 78069

Figure 29 – Exhaust Tube and Muffler – Installed

60. MUFFLER.

a. **Construction.** The exhaust muffler (fig. 29), a long steel cylinder, is strapped to the frame at the right of the engine. Near the rear of the muffler, a split sleeve fitting is welded to the jacket. A U-bolt is provided around the split sleeve for holding the muffler to the exhaust pipe. The front end is fitted with a 2-inch pipe extending beyond the muffler to receive the flexible exhaust tube. Asbestos sheeting covers the entire muffler.

b. **Functioning.** The muffler deadens the sound and shock of the exhaust by means of an arrangement of baffles, tubes, and passages. The asbestos sheeting insulates the unit from the heat of the exhaust.

c. **Maintenance.** The only requirements for muffler maintenance are inspection for cracks or evidence of burning out, checking for tightness of connections and for deterioration of asbestos insulation. Troubles or defects call for immediate replacement.

d. **Removal.** For instructions on removing muffler, see paragraph 59 c.

e. **Installation.** For instructions on installing muffler, see paragraph 59 d.

61. FLEXIBLE EXHAUST PIPE.

a. **Description.** A 2-inch flexible steel pipe, 44 inches long, is carried in rings under the right-hand side of the tool box and battery

FUEL SYSTEM

shelf (fig. 6) to be used in carrying away exhaust gases when the unit is in operation. One end of the tube is fitted with an adjustable steel ring for clamping over the muffler extension that projects through the front apron. The other end is finished off with a narrow steel ferrule.

Section XII
FUEL SYSTEM

	Paragraph
Description	62
Gasoline tank	63
Fuel pump	64
Carburetor	65
Air cleaner	66
Governor	67
Throttle body	68

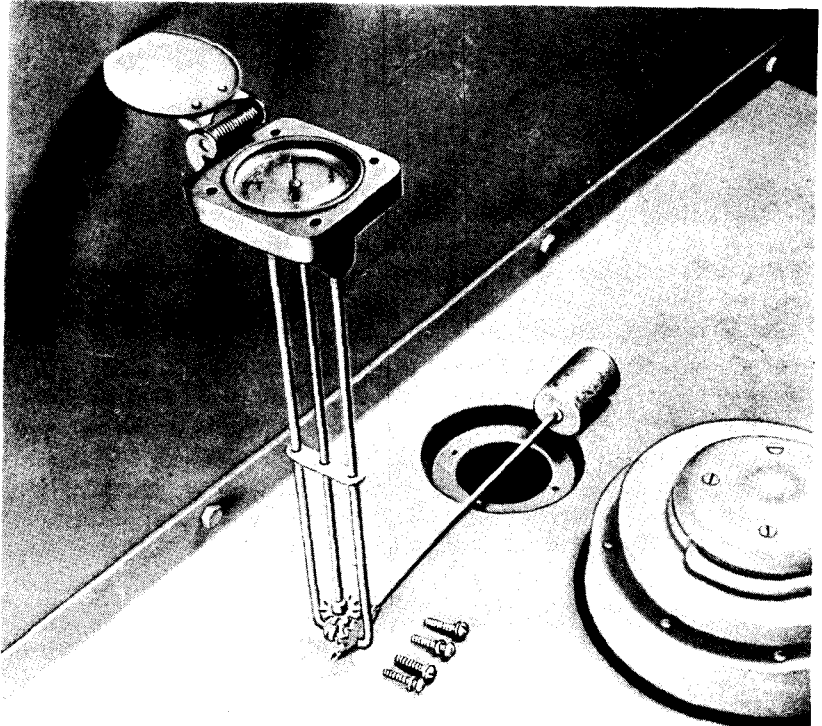

RA PD 56934

Figure 30 – Fuel Gage Removed

GENERATING UNIT M18

RA PD 78078

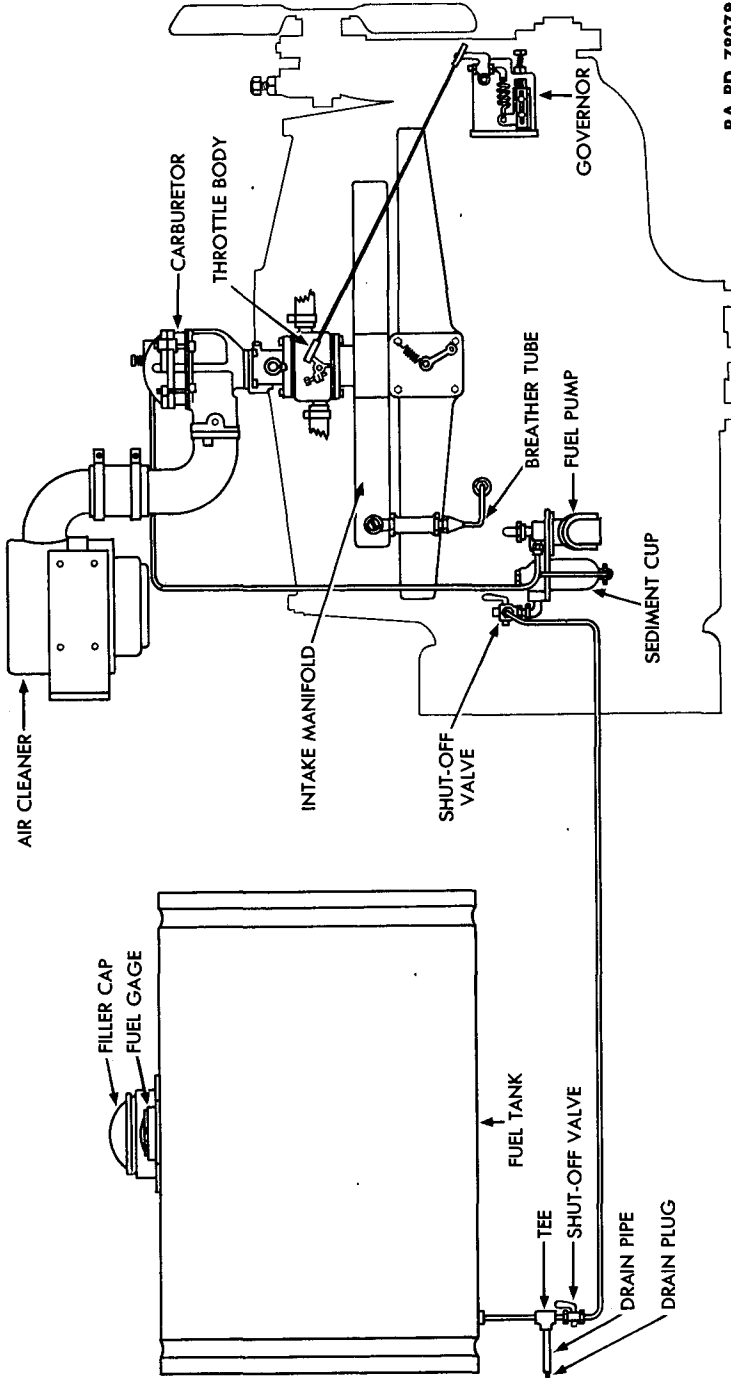
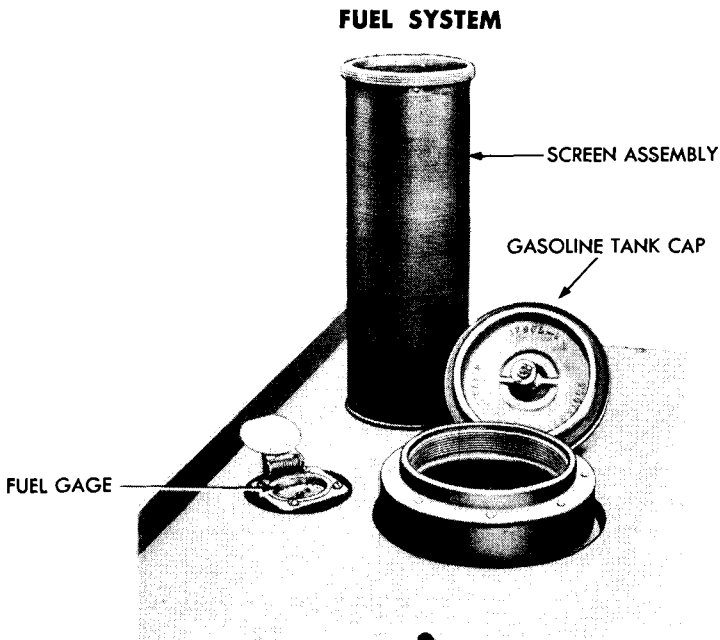

Figure 31 — Fuel System Diagram



RA PD
78066

Figure 32 – Gasoline Tank Filler Cap and Screen

62. DESCRIPTION (fig. 31).

a. Construction. The fuel system consists of the gasoline tank with a flameproof filler cap and screen (fig. 32), and a mechanical, float-type fuel gage (fig. 30), the fuel pump, the carburetor, the air cleaner, the intake section of the manifold, the governor, the throttle body, linkage between governor and throttle body, a $\frac{5}{16}$ -inch fuel line (fig. 33), and a $\frac{1}{4}$ -inch drain line. The drain line consist of a nipple teed off the fuel line at the lower right front corner of the fuel tank. The capacity of the fuel tank is 25 gallons.

b. Functioning. Suction action of the fuel pump brings the fuel from the tank to the pump, which then forces it to the top of the carburetor, where it is converted into an air and fuel vapor mixture. The suction of the engine pistons pulls the air through the air cleaner into the carburetor where it picks up fuel vapor. The mixture is then drawn through the throttle body to the intake section of the manifold. The governor (fig. 41), operated from the timing gear, is set to hold the engine at a predetermined speed. The choke, operated manually from the instrument panel, regulates the air supply, and thereby makes the fuel mixture rich. The throttle, also operated manually from the instrument panel, regulates the amount of mixture supplied to the engine.

63. GASOLINE TANK.

a. Construction. The gasoline tank is located at the rear of the

GENERATING UNIT M18

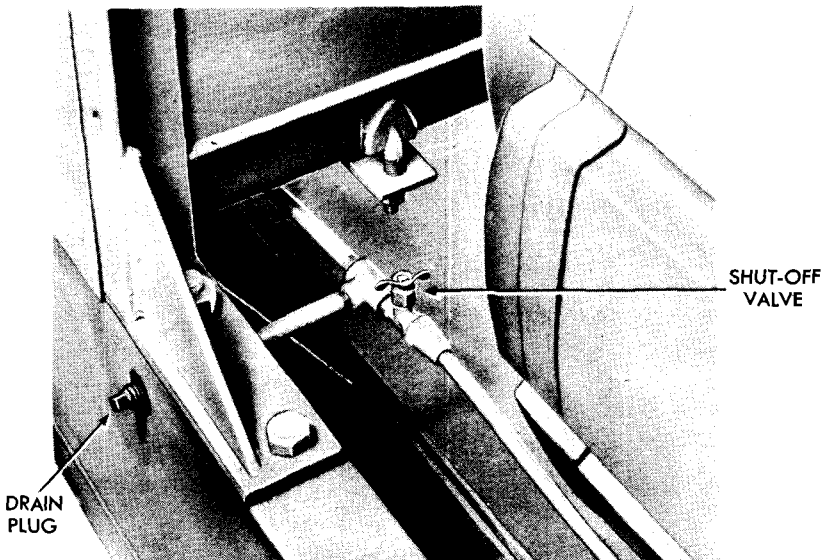

RA PD
78075

Figure 33 – Fuel Line at Tank

unit, enclosed by a sheet metal guard. The fuel line feeds from a bottom pipe tap on the right-hand side. The filler neck is provided with a special flame-arrester screen (fig. 32).

b. Maintenance. The platform underneath the gasoline tank should be inspected frequently for signs of leaks. Tank connections should also be inspected and tested frequently. The fuel gage should be checked frequently. Its accuracy can be determined by the indications before and after filling.

64. FUEL PUMP.

a. Description. The fuel pump (fig. 34) is a mechanical, diaphragm-type, which is attached to the crankcase and operated by an eccentric on the engine camshaft. The vacuum created by the pump draws the fuel from the tank to the pump. The diaphragm then forces the fuel from the pump to the carburetor. Before the fuel reaches the pump proper, it flows through a strainer into a removable glass sediment cup where water and impurities fall to the bottom. The fuel flow passes across the top of this cup.

b. Maintenance. The glass sediment cup should be examined daily, and emptied whenever water is found at the bottom. The cup and the wire mesh strainer above it (fig. 35) should be cleaned frequently by washing in SOLVENT, dry-cleaning.

FUEL SYSTEM

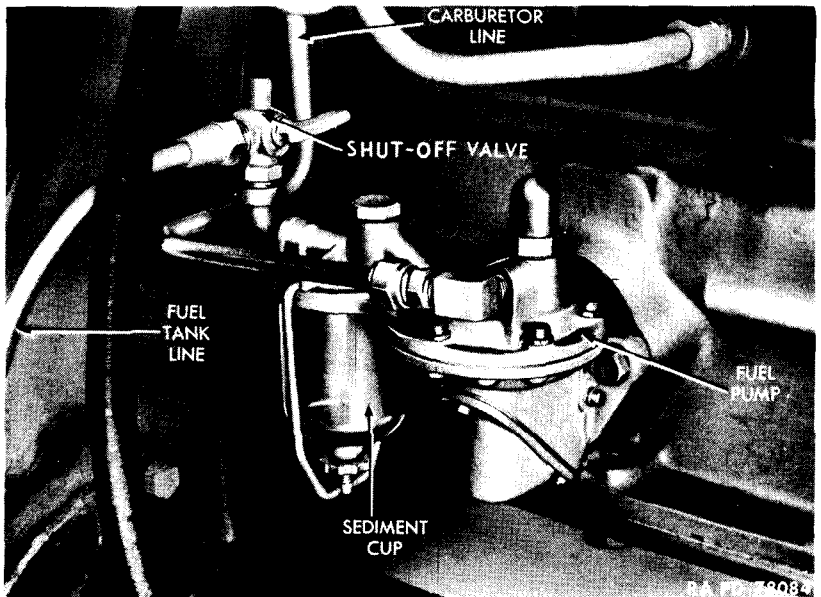

Figure 34 – Fuel Pump – Installed

c. Removal.

- (1) Disconnect fuel tank line and carburetor line at fuel pump (fig. 34).
- (2) Take out the two cap screws and lock washers that hold the pump to the engine, and remove pump assembly (fig. 36).

d. Installation.

- (1) Install pump at slight upward angle (fig. 36) to get pump lever into its proper position on the camshaft. If some resistance is not met against the lever pressure, the lever is not riding against the cam, and the angle should be altered slightly and tried again. When the pump is correctly positioned, secure to engine with cap screws and lock washers. Use new gasket when installing pump.
- (2) Connect fuel tank line and carburetor line to fuel pump (fig. 34).

65. CARBURETOR.

a. Description. The carburetor (fig. 37) is a downdraft type, located over the intake section of the manifold above the throttle body. It is connected by a cast-iron elbow to the air cleaner. The fuel intake is controlled by a float-regulated needle valve that maintains a constant fuel level in the chamber as the suction of the pistons draws the mixture down to the intake manifold. At the top of the carburetor is an adjusting screw which controls the amount of air

GENERATING UNIT M18

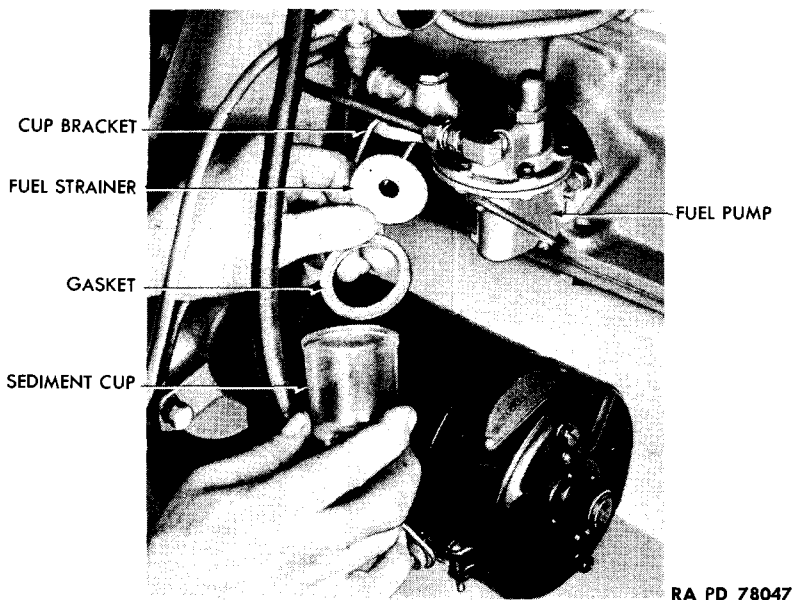

Figure 35 – Sediment Cup and Fuel Strainer Removal

drawn into the idling jet. This controls richness of the air and fuel mixture for idling speed only. The idling fuel vapor section of the carburetor is inoperative as soon as the main throttle is opened, and the engine has reached high speed. Throttle and choke adjustment levers on the carburetor have linkage connections to instrument panel knobs that adjust the amount of air and fuel taken into the carburetor during starting and stopping.

b. Maintenance.

(1) **INSPECTION.** The carburetor needs very little attention if properly installed. Inspect for air leaks, and check for worn or faulty gaskets.

(2) **ADJUSTMENT.** When necessary, adjust idling mixture adjusting screw at top of carburetor. Turning clockwise makes richer mixture; counterclockwise, leaner mixture (fig. 37).

c. Removal (fig. 38).

(1) Loosen nut on compression fitting at back of carburetor, and disconnect fuel line from carburetor.

(2) Remove cap screws securing elbow to carburetor.

(3) Loosen screws securing choke, and throttle wire to carburetor, and remove wires.

(4) Unscrew nuts holding carburetor to throttle body and remove carburetor. **NOTE:** Remove nut at right side of carburetor first.

FUEL SYSTEM

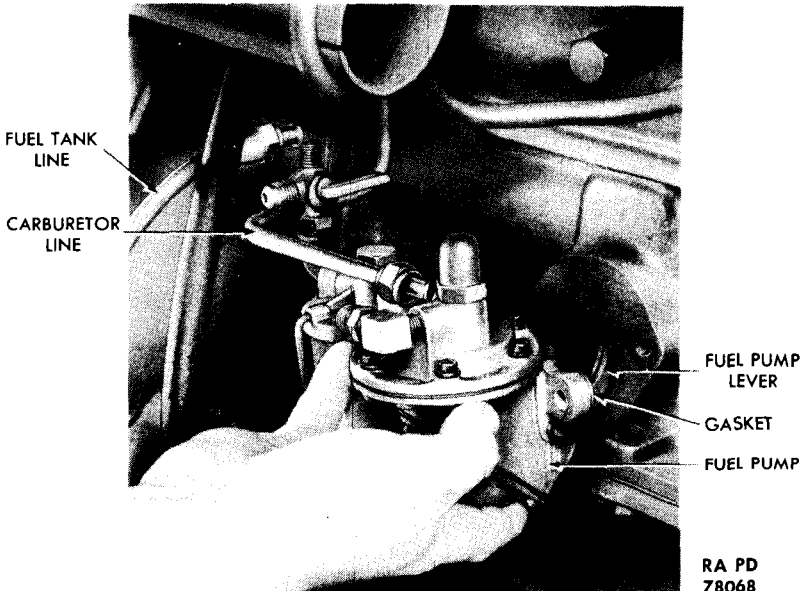

RA PD
78068

Figure 36 – Fuel Pump Installation

d. Installation (fig. 38).

(1) With gaskets in place on throttle body, place carburetor in position on throttle body and secure with two nuts. Tighten nuts evenly to prevent breaking lower carburetor flange.

(2) Place gasket between carburetor and elbow and secure elbow to carburetor with two cap screws.

(3) Attach throttle wire to throttle lever and choke wire to choke lever on carburetor.

(4) Carry compression fitting nut over the end of the fuel line, bring fuel line into fitting, and tighten nut to produce a firm joint. Start engine and check for gasoline leaks:

66. AIR CLEANER.

a. Description. The air cleaner (fig. 39) is the oil bath type and is mounted on the right center frame post above the rear of the engine. It is connected to the carburetor by a cast-iron elbow and a section of 2¼-inch rubber hose, 4 inches long. It has a removable cup which houses a deflector element. The upper section, or body, is filled with steel wire mesh. A removable filter element is attached between the cup and the body. The cup is readily removed to permit cleaning the elements inside.

b. Functioning. The function of the air cleaner is to remove all dust and dirt from the air before the air enters the carburetor. Air

GENERATING UNIT M18

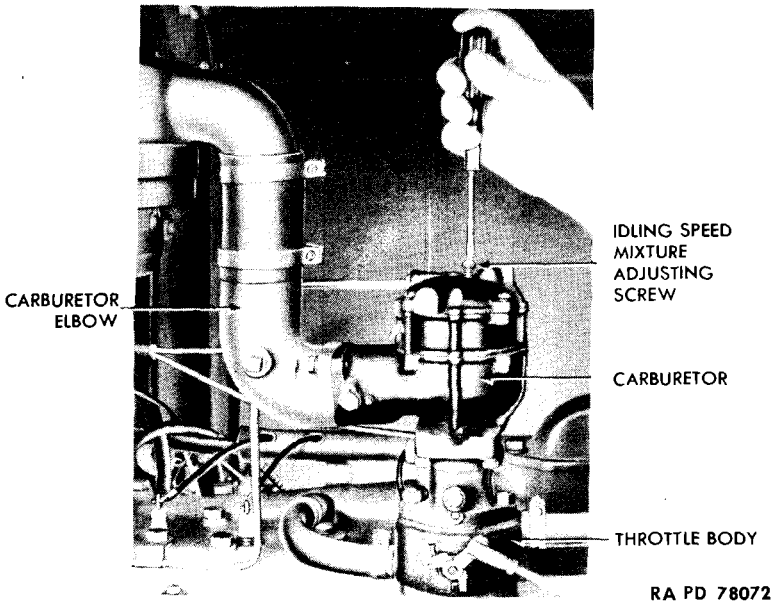

Figure 37 – Carburetor Adjustment

drawn into the carburetor enters the cleaner through the aperture between the cup and body of the cleaner. Air entering the cleaner passes into the oil chamber where, due to impact and sudden reversal of air flow, most of the dust in the air is thrown into the oil in the cup and settles to the bottom of the cleaner. The partially cleaned air passes through dense oil-wetted, steel-wire mesh where the remaining dust is trapped.

c. Maintenance. Daily, or more often in severe dust conditions, inspect the air cleaner by removing cup, to determine if steel-wire elements, deflector, and oil in cup are dirty (fig. 40). If so, empty oil from cup and clean each unit by washing in SOLVENT, dry-cleaning. Place the clean deflector in cup and fill cup with OIL, engine (seasonal grade), to level indicated on the center of the deflector. To remove air cleaner cup, push cup up against cleaner body, rotate to left, and lower away from cleaner body. If, on inspection, the steel-wire mesh in cleaner body appears to be dirty, remove entire cleaner assembly and clean mesh in body with SOLVENT, dry-cleaning, and allow to dry.

d. Removal (fig. 39).

(1) Loosen screw on hose clamp securing hose to air cleaner elbow.

(2) Loosen nut on cap screw through clamp securing air cleaner assembly to cleaner bracket.

FUEL SYSTEM

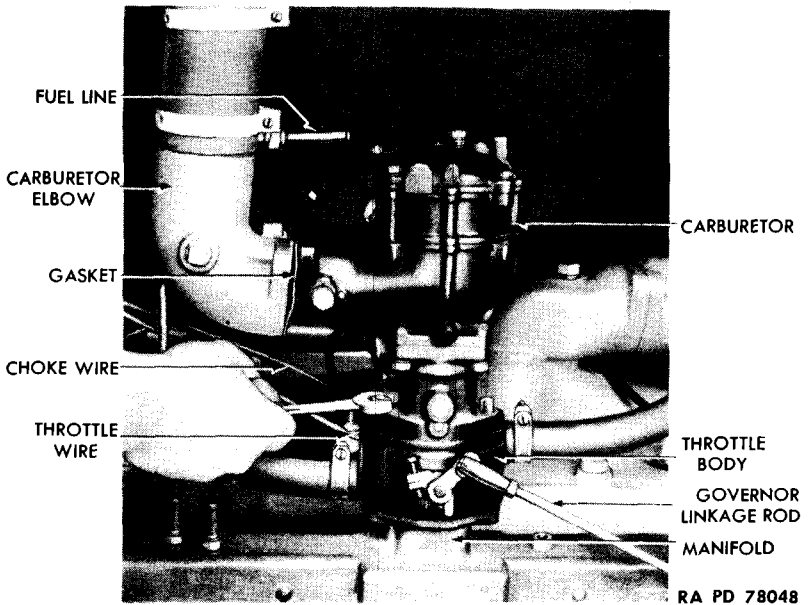

Figure 38 – Carburetor Removal

(3) Lift air cleaner assembly sufficiently to clear clamp, and remove.

e. Installation (fig. 39).

(1) With hose and clamps in position on carburetor elbow, place air cleaner assembly through clamp so that cleaner elbow enters hose.

(2) Tighten cap screw and nut on air cleaner clamp to secure cleaner to bracket.

(3) Position hose clamp on cleaner elbow end of hose and secure with screw furnished.

67. GOVERNOR.

a. Construction. The governor (fig. 41) is a gear-driven, spring-loaded, flyball-type unit mounted on the right front side of the timing gear cover. It is connected through linkage with the throttle body valve.

b. Functioning. The governor, driven from the camshaft gear, controls the amount of opening of the throttle body valve. It has a calibrated spring control held at a predetermined setting, which should not be changed without permission of higher authority.

c. Adjustment. As put in service, the governor is adjusted to keep the engine running at 1,200 rpm, full load, and 1,230 rpm, no load. This adjustment should be carefully maintained. The following in-

GENERATING UNIT M18

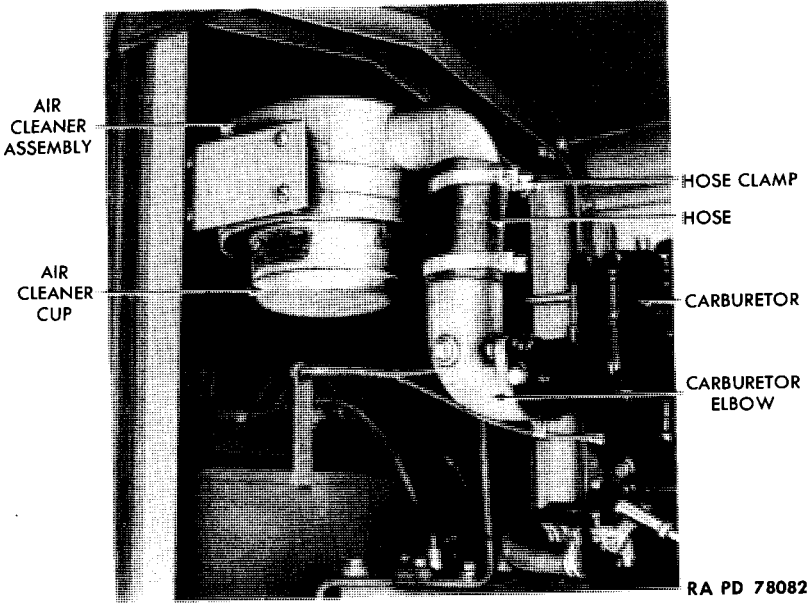

Figure 39 - Air Cleaner - Installed

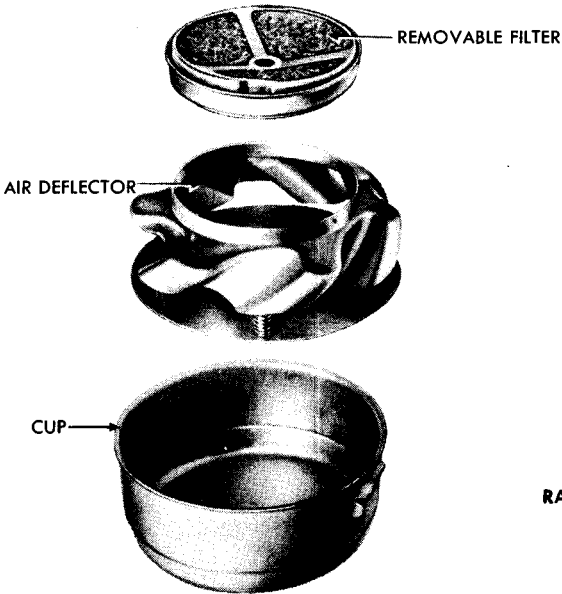

Figure 40 - Air Cleaner Servicing Units

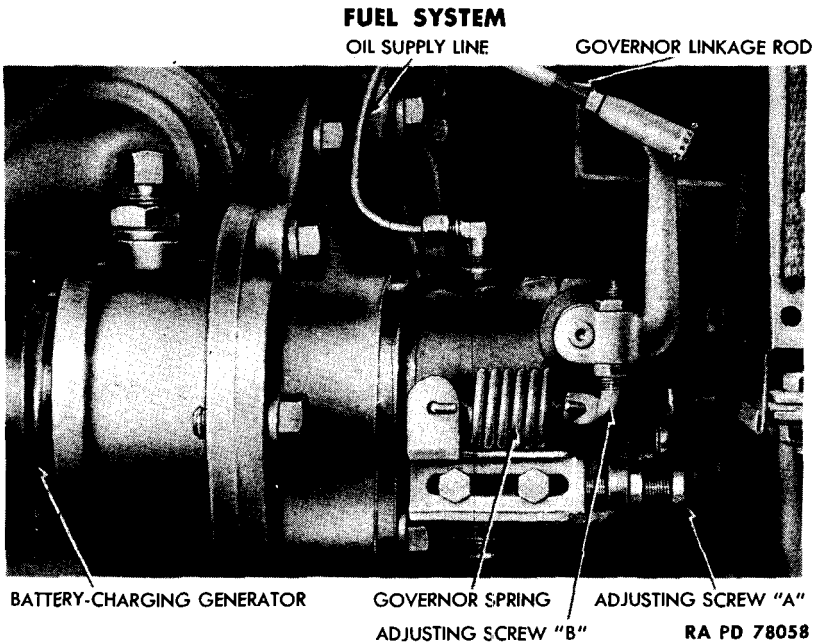

Figure 41 – Governor – Installed

formation will aid in minor adjustment. Other adjustments should be made only under supervision of higher authority.

(1) To increase speed, increase the spring tension by screwing in adjusting screw "A" (fig. 41). To decrease speed, decrease the spring tension. Be sure to tighten the lock nut after making an adjustment.

NOTE: Do not change the adjustment of adjusting screw "B" without permission from higher authority.

(2) The linkage, or rod, connecting the governor arm to the throttle body valve arm must be of the correct length, and the throttle arm must be set so that it is at right angles to the rod when it is in the middle of its travel, thus giving free movement from an "OPEN" to a "CLOSED" position. Also, the throttle and joints of the rod must be absolutely free during the full travel of the parts. The rod is adjustable as to length and must be adjusted so that, with unit at rest and governor and throttle in their normal "WIDE-OPEN" positions, it will hold the throttle arm about $\frac{1}{64}$ inch away from its "WIDE-OPEN" position. There will usually be some tension on the spring when the unit is at rest. If there is no tension, when checking for length of rod as outlined above, be sure the governor arm is all the way back in the direction the spring would pull it.

68. THROTTLE BODY.

a. **Description.** The throttle body (fig. 42), mounted between the intake manifold and the carburetor, houses the throttle valve

GENERATING UNIT M18

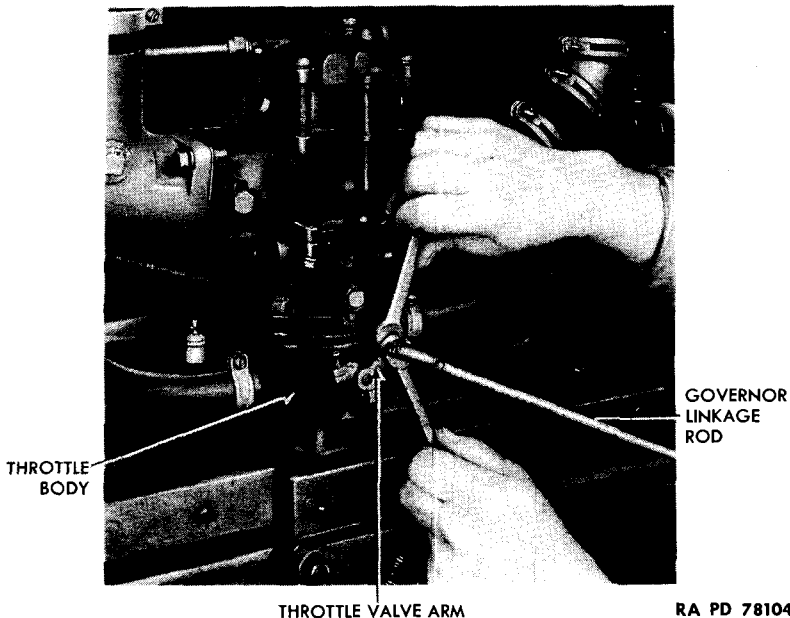

Figure 42 – Governor Linkage Rod Removal

RA PD 78104

which is controlled by the action of the governor. The valve regulates the amount of fuel mixture entering the intake manifold to the engine cylinders thereby controlling the operating speed of the engine. Proper fuel temperature is maintained by water circulating through the body.

b. Maintenance. Periodically apply a few drops of OIL, engine (seasonal grade), to valve shaft extending through body at lever end and to the ball and socket joints attached to governor lever rod. Visually check for damaged gaskets between throttle body and manifold, and throttle body and carburetor. Apply a screwdriver to hose clamp screws to assure proper hose connections.

c. Removal (fig. 42).

- (1) Drain cooling system to level below cylinder head.
- (2) Disconnect governor linkage rod at throttle valve arm (fig. 42).
- (3) Remove carburetor (par. 65 c).
- (4) Loosen the hose clamps securing hoses to throttle body and remove hoses.
- (5) Lift throttle body from manifold.

d. Installation (fig. 42). Procedure for installing throttle body is the reverse of subparagraph c, above. Carefully inspect gasket before installing.

Section XIII
ENGINE LUBRICATION SYSTEM

	Paragraph
Description	69
Filter	70
Strainer	71
Oil pump	72

69. DESCRIPTION (fig. 44).

a. The engine oil system provides continuous lubrication by means of a submerged-type gear pump driven from the camshaft. From the oil sump at the bottom of the crankcase, the pump draws oil through a strainer screen (fig. 44) and forces it to the main oil gallery, drilled in the cylinder block on the side opposite the camshaft. From here the oil is forced to the main and connecting rod bearings, front camshaft bearing, and governor. The rear and center camshaft bearings, cylinder walls, pistons, and valve tappets are all lubricated by oil thrown from ends of main and connecting rod bearings.

b. A certain amount of the oil forced to the gallery is taken off through a bypass, sent through the oil filter (fig. 44) and back to the sump. A pressure regulating valve on the gallery operates to allow oil to flow directly back to the sump when the oil pressure becomes

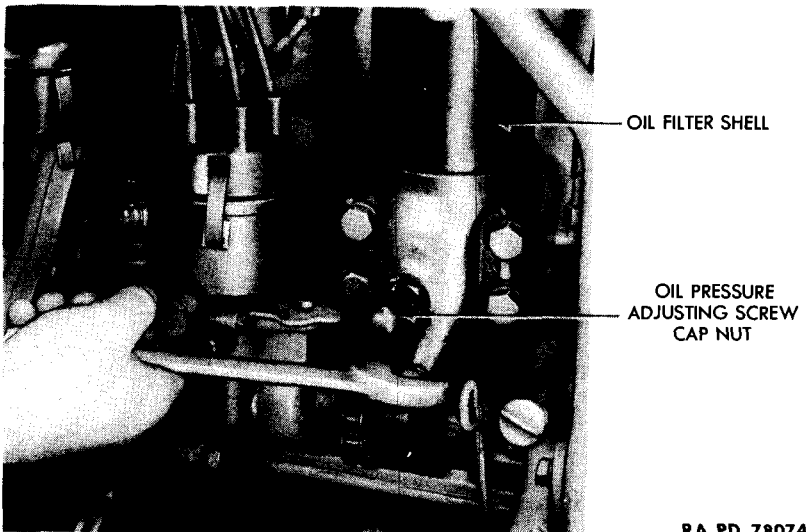

Figure 43 – Removing Sludge Drain Screw from Filter Base

GENERATING UNIT M18

RA PD 78113

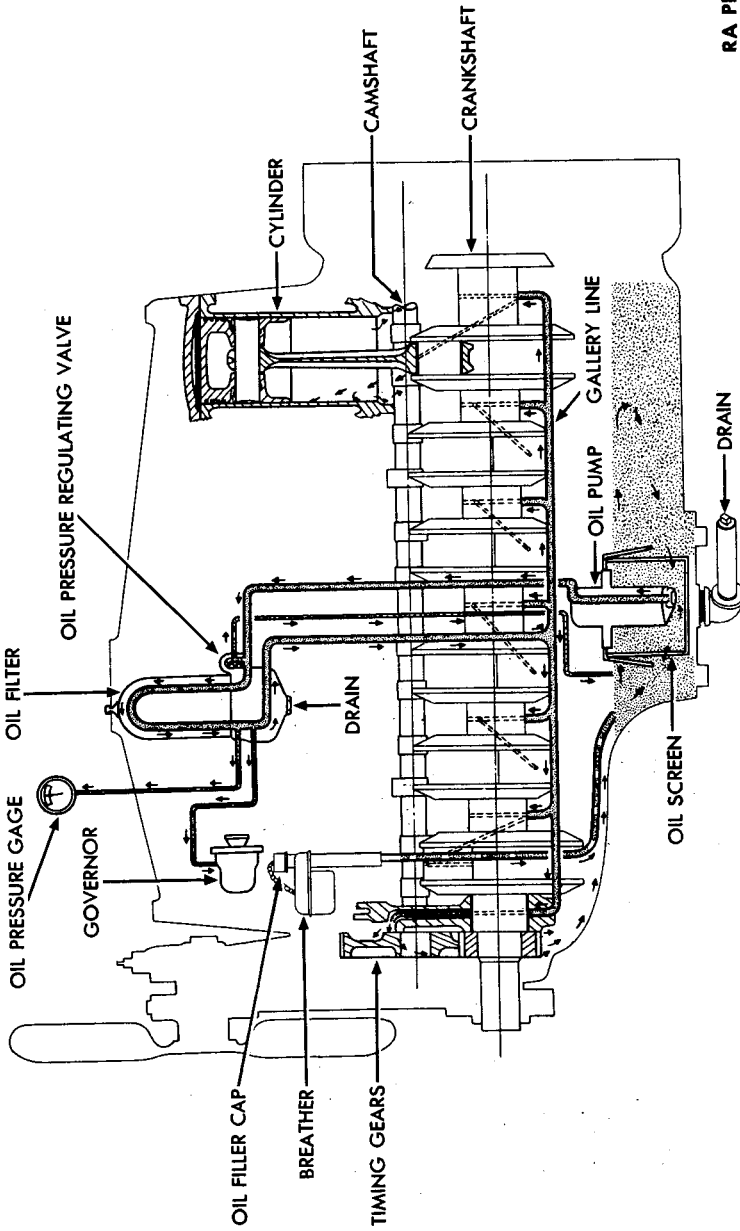

Figure 44 — Engine Lubrication System

ENGINE LUBRICATION SYSTEM

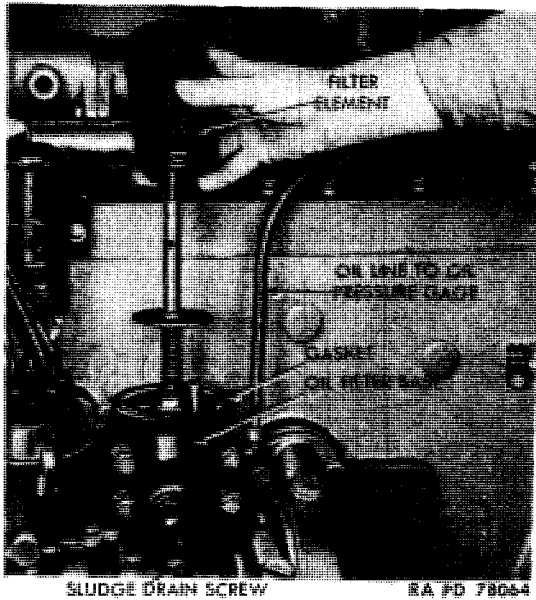

Figure 45 – Removing Oil Filter Element

too great. The pressure regulating valve is adjustable by means of a screw (fig. 46) in the base of the oil filter. This valve is adjusted at the factory when the unit is regulated and must not be disturbed except under supervision of higher authority.

c. The oil filler pipe (fig. 44), which also functions as a crankcase breather, is located on the left front side of the engine and is provided with a filler cap and an air cleaner assembly. The filler pipe cap is painted red. Other oilers and grease fittings are identified by a red circle $\frac{3}{4}$ inch in diameter. Approximately 7 quarts of oil are needed for the oil pan, an additional quantity being required for the oil filter. From a tapped hole in the base of the oil filter, a copper tubing oil gage line leads to the oil gage on the instrument panel. The oil pressure should be approximately 25 pounds at 1,200 rpm, with the unit fully warmed up. When it is first started, the pressure will be slightly higher.

70. FILTER.

a. **Construction.** The oil filter (fig. 44), on the left side of the engine next to the distributor, has a heavy-gage steel, dome-shaped shell over a filter element of round felt pads about a center tube.

b. **Functioning.** The oil is pumped, under pressure, up through the filter tube; it comes out at the top and flows down over the filter

GENERATING UNIT M18

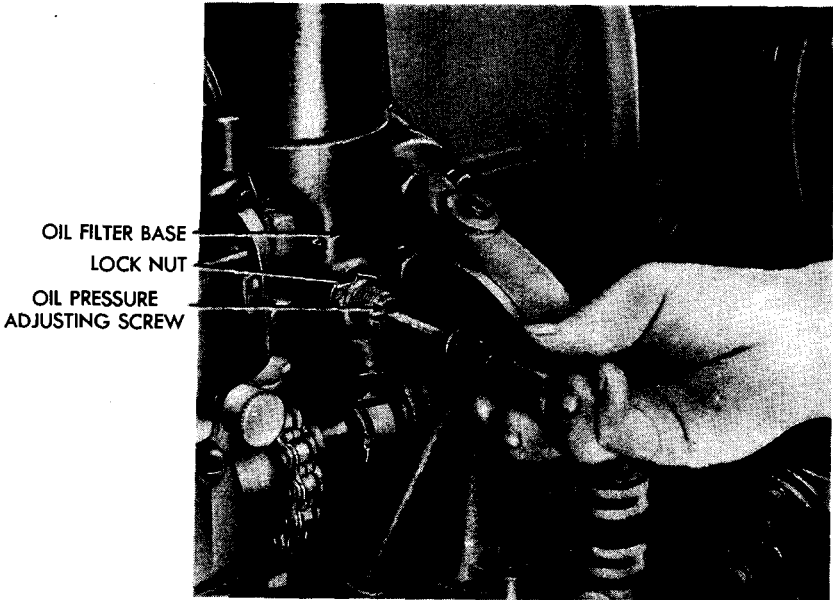

RA PD 78052

Figure 46 – Oil Pressure Adjustment

element, leaving dirt and other foreign substances on the surface of the element. A sludge screw (fig. 43) in the filter base allows sludge to be drained. A fitting at the top of the casing can be taken off and, with the sludge screw removed, the filter may be blown out.

c. Maintenance. The oil filter should be cleaned either by blowing out with air, or by scraping the element at frequent intervals, or whenever the oil becomes discolored. For further cleaning, the element should be washed in SOLVENT, dry-cleaning.

d. Filter Element Removal (fig. 45).

- (1) Unscrew top fitting over shell and lift off gasket and shell.
- (2) Unscrew washer at top of filter element and lift out element as a unit.

e. Filter Element Installation. NOTE: Before installing filter element, thoroughly clean sludge and dirty oil from filter body.

- (1) Slide filter element on tube (fig. 45) and secure in position by screwing threaded washer down tube against filter.
- (2) Install shell and secure in position with top fitting. Use gasket under top fitting.
- (3) Start engine and check for oil leaks about oil filter. An oil leak may denote faulty gasket at top or bottom of filter shell, or improper assembling of shell.

ENGINE ELECTRICAL SYSTEM

71. STRAINER.

a. **Description.** The oil strainer (fig. 44) is of wire mesh on a steel frame attached to a removable cap at the bottom of the crankcase. The oil pump draws the oil through the strainer mesh.

b. **Maintenance.** The oil strainer should be removed periodically, and cleaned thoroughly with SOLVENT, dry-cleaning.

72. OIL PUMP.

a. **Description.** The oil pump is of the submerged type, gear-driven from the camshaft. The pump forces oil from the oil sump at the bottom of the crankcase to the points to be lubricated.

b. **Maintenance.** The oil pump requires no maintenance when working properly. Repairs are not within the scope of this manual. Oil pressure can be adjusted by the pressure regulating valve (fig. 46), but this may be done only under supervision of higher authority. To adjust oil pressure proceed as follows:

(1) Take off oil pressure adjusting screw cap nut and gasket. Loosen lock nut holding adjusting screw.

(2) Turn adjusting screw until the oil pressure gage on the instrument panel registers 25-pound pressure at 1,200 rpm. Tightening the screw increases the pressure, loosening the screw decreases pressure. NOTE: The oil pressure should not be changed or judged to be too high or too low until it is known that the proper weight of oil is being used, and the engine is being warmed up to normal operating temperature. As the bearings become worn, more oil will escape around the bearings into the case, lowering the pressure slightly. It is not advisable to try to correct this slight loss of pressure by an adjustment of the pressure regulator because the extra amount of oil being thrown off by the worn bearings is already overoiling the cylinder walls.

Section XIV

ENGINE ELECTRICAL SYSTEM

	Paragraph
Description	73
Batteries	74
Battery-charging generator	75
Ignition coil	76
Distributor	77
Spark plugs	78
Starting motors	79

73. DESCRIPTION (fig. 47).

a. The starting and ignition system consists of two 6-volt batteries located in boxes bolted to the shelf above the generator on the right-

GENERATING UNIT M18

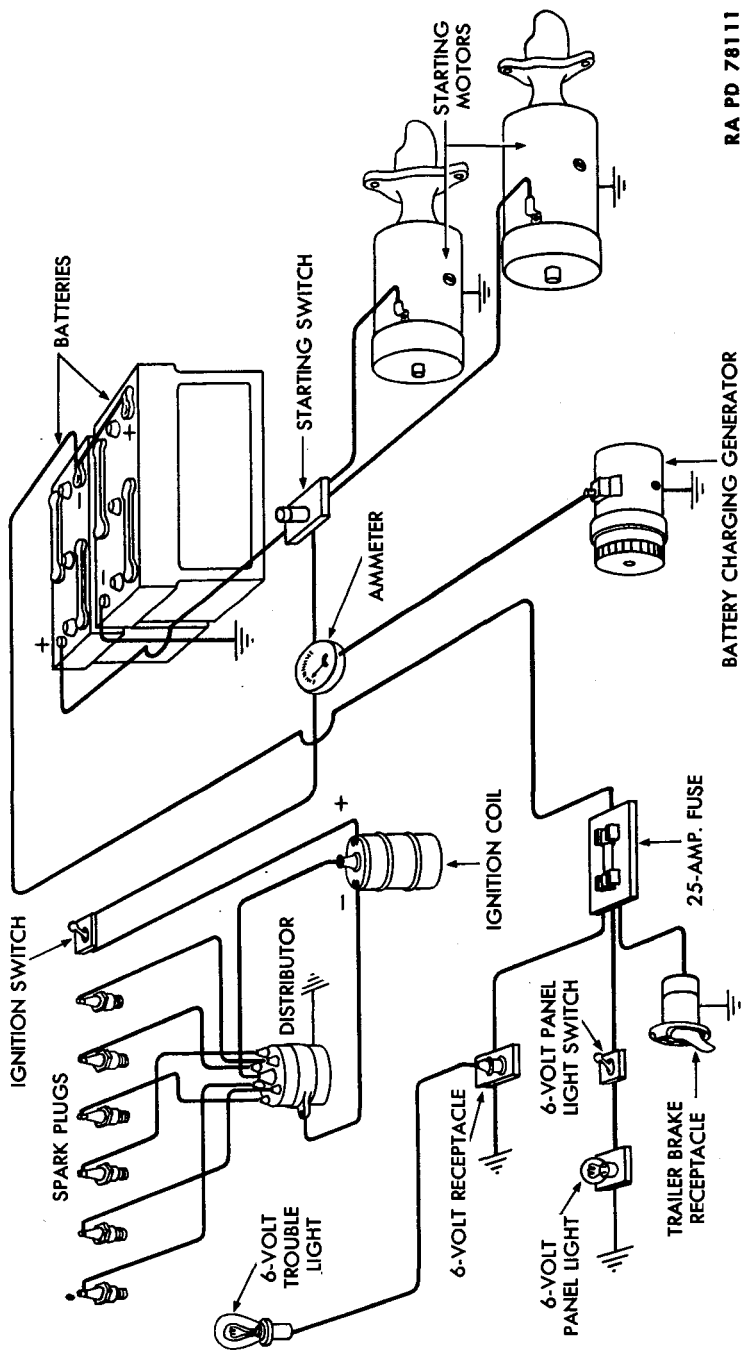

RA PD 78111

BATTERY CHARGING GENERATOR

Figure 47 — Engine Electrical System

ENGINE ELECTRICAL SYSTEM

RA PD
78098

Figure 48 – Checking Battery Charge with Hydrometer

hand side of the unit, opposite the instrument panel; a 12-volt battery-charging generator (fig. 53), on the right side of the unit under the manifold; two 12-volt starting motors (fig. 63), one on the left and the other on the right side of the engine, projecting through the bell housing; a distributor (fig. 56) mounted on the accessory drive; an ignition coil (fig. 14) bolted to the left side of the engine head; and the spark plugs. An ignition switch and a battery-charging generator ammeter are located on the instrument panel. The starter switch (fig. 13) is mounted on a bracket above the left starting motor. Two slave terminals (fig. 13) are provided on this bracket to facilitate connecting additional batteries to the unit when required.

b. Functioning.

(1) **STARTING.** The ignition switch on the instrument panel throws on the 12-volt current in the ignition line. The starting switch makes the connection to the starting motors which crank the engine.

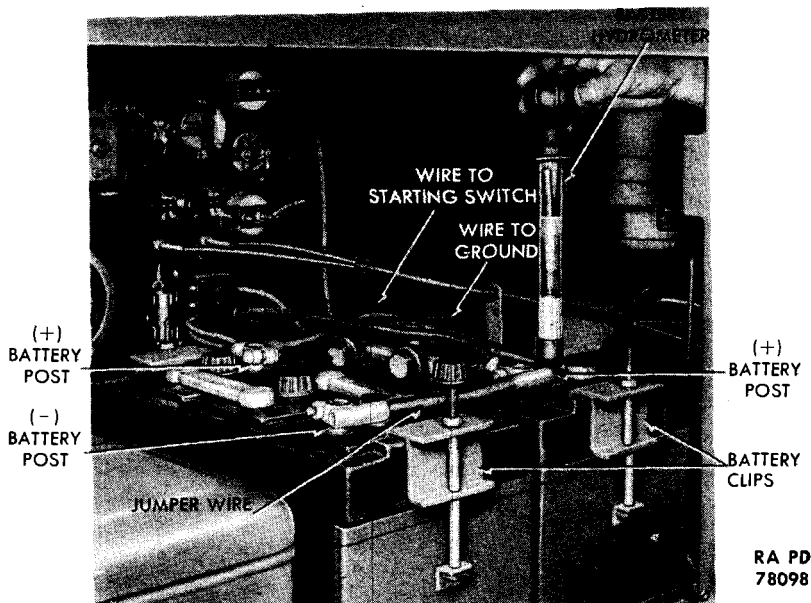
(2) **IGNITION.** The battery circuit furnishes the electric spark that ignites the mixture in the cylinders. The ignition switch connects the battery line to the ignition coil, which transforms the 12-volt current to the high voltage required to produce the hot spark necessary for cylinder ignition. The distributor makes the succession of momentary contacts that pass the high-voltage current to the spark plugs in the proper firing order.

GENERATING UNIT M18

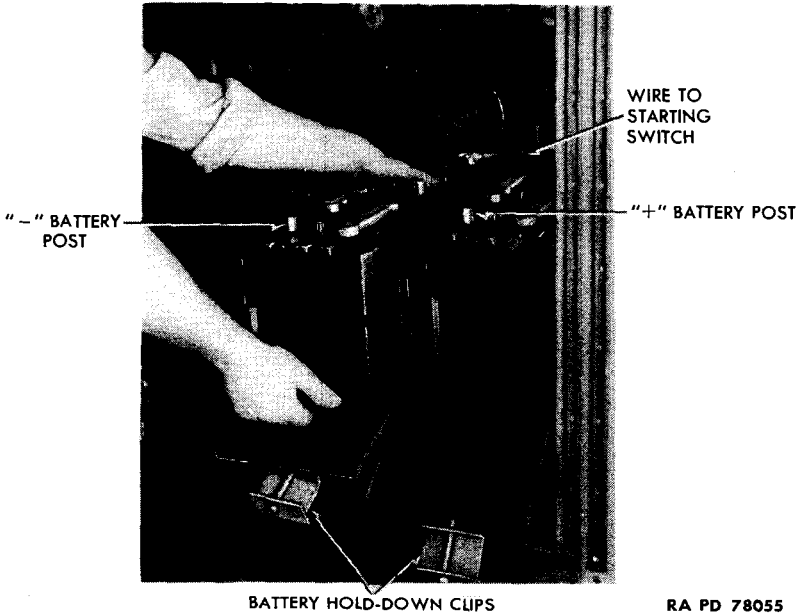

Figure 49 - Removing Batteries

(3) **LIGHTING.** The battery line provides an auxiliary lighting circuit for use when the generator is not functioning. A 6-volt pilot light is located on the instrument panel, and a 6-volt receptacle is also provided there to receive the 6-volt trouble light carried in the tool box.

74. BATTERIES (fig. 48).

a. Description. The batteries are located on the right-hand side of the unit, opposite the instrument panel. The negative (-) post of the front battery is grounded through a wire attached to the engine bell housing. The wire from the positive (+) post of the rear battery is connected to the live side of the starting switch. The two 6-volt batteries are connected in series to provide the required 12-volt current for the engine electrical system. The capacity of each battery is 160 ampere-hours at 20-hour rate.

b. Maintenance (fig. 48).

(1) The batteries should always be kept filled with distilled water if available; otherwise, with rain water collected in a nonmetallic container, to a point approximately $\frac{3}{8}$ inch above the separators. If the unit is used regularly, the batteries should stay in proper charged condition. An idle battery loses its charge. If hydrometer test shows batteries are discharged, they should be charged by a standard auxiliary battery charger. If this is impossible, they can be charged by the battery-charging generator on the unit. The engine must be

ENGINE ELECTRICAL SYSTEM

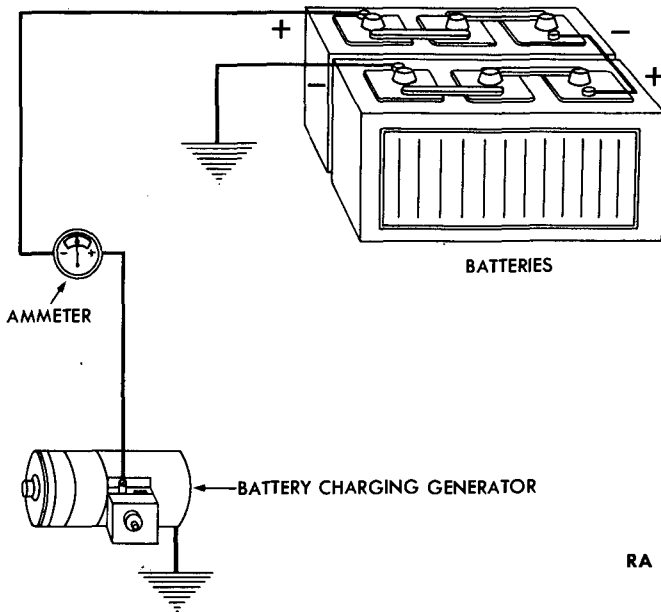

RA PD 78063

Figure 50 – Engine Electrical System – Generator Circuit

started by hand-cranking, and complete charging will take upward of 20 hours.

(2) The batteries and their compartments must be kept clean and dry, and the vent plugs tight, although the breather holes in the latter must be kept open.

(3) Cables and terminals should be kept tight or the proper connections cannot be maintained. Scrape clean with a coarse wire brush, and then wash surface with hot water and soap. After connecting cables to battery terminals, coat terminals with **GREASE**, general purpose (seasonal grade).

(4) For care of batteries in hot and cold climates, see section VI.

c. Removal (fig. 49).

(1) Disconnect cable lugs from battery terminals, holding square head of bolt with pliers, and unscrewing nut with open-end wrench.

(2) Loosen the nuts securing battery clips against battery and lift clips from battery. When lifting front clips, the hinged section of each battery box will swing down out of position, permitting easy removal of the batteries.

(3) Lift batteries from their boxes.

d. Installation (fig. 49).

(1) Thoroughly clean battery boxes before installing batteries.

(2) Place batteries in their boxes with negative (-) post of front

GENERATING UNIT M18

TWO CHARGE REGULATOR

BRUSH

BRUSH HOLDER

FUSE HOLDING CAP

PAPER, FLINT

RA PD 78118

Figure 51 – Fitting Generator Brush to Commutator

battery (battery nearest engine), and positive (+) post of rear battery toward instrument panel.

(3) Place battery clips in position over ends of batteries and secure batteries in position by tightening battery clip nuts.

(4) Attach wire, grounded to engine bell housing, to negative (-) post on front battery and wire to starting switch to positive (+) post on rear battery. Attach jumper wire connecting front battery positive (+) post with rear battery negative (-) post. Connect wire leading from No. 61 on terminal block on instrument panel to positive (+) post connection on front battery.

75. BATTERY-CHARGING GENERATOR (fig. 50).

a. Construction. The battery-charging generator is a 2-pole, shunt-wound, third-brush regulated, ventilated unit with a capacity of 12 volts. A 2-charge voltage regulator is mounted on the generator frame, and combines the cut-out with the regulator. A 5-ampere fuse (fig. 55) is mounted in the regulator.

b. Functioning. The generator produces current for charging the batteries. The regulator allows the generator to charge at its high rate until the batteries are nearly charged, and have reached a pre-determined voltage, at which time a resistance is cut into the field circuit of the generator, reducing the charging rate approximately one-half. The cut-out acts as an automatic switch between the gen-

ENGINE ELECTRICAL SYSTEM

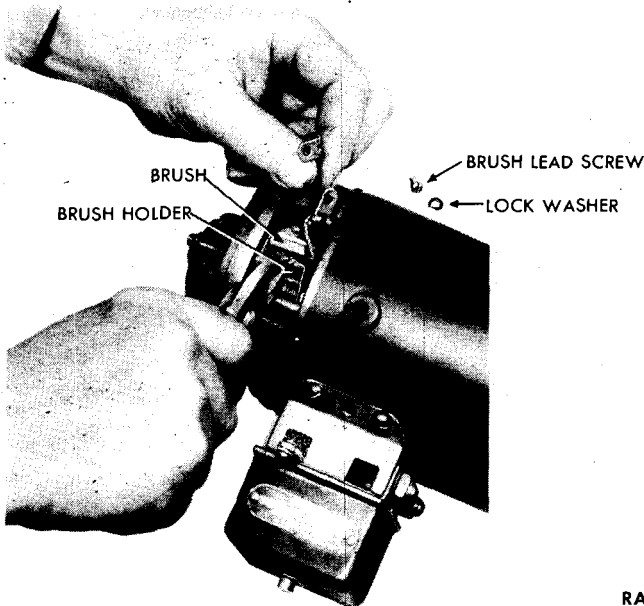

RA PD 78117

Figure 52 — Generator Brush Installation

erator and the batteries, closing the circuit when the generator is producing sufficient output to charge the batteries, and opening the circuit when the generator is not charging, so as to prevent the batteries from discharging back through the generator.

c. Maintenance.

(1) To inspect the battery-charging generator, remove the cover at the commutator end. If the commutator is discolored or dirty, it can be cleaned by holding a piece of PAPER, flint, class B, No. 00, against it while the generator is running slowly.

(2) BRUSHES.

(a) If brushes are badly worn, new brushes should be installed. The brushes should be fitted to have at least 80 percent brush surface contact with the commutator. To fit the brushes, clean the commutator (step (1), above); then wrap around the commutator a piece of PAPER, flint, class B, grade No. 00, of the same width as the commutator, and move it back and forth along the commutator with sanded face against brushes (fig. 51). Turn the commutator clockwise from drive end until brushes seat properly. Blow the generator out with compressed air to remove all particles of abrasive. Never use CLOTH, abrasive, aluminum-oxide, oil, or grease on commutators.

(b) Brush spring tension can be tested by hooking a scale in the hole at the end of the brush arm, and taking a reading as the arm

GENERATING UNIT M18

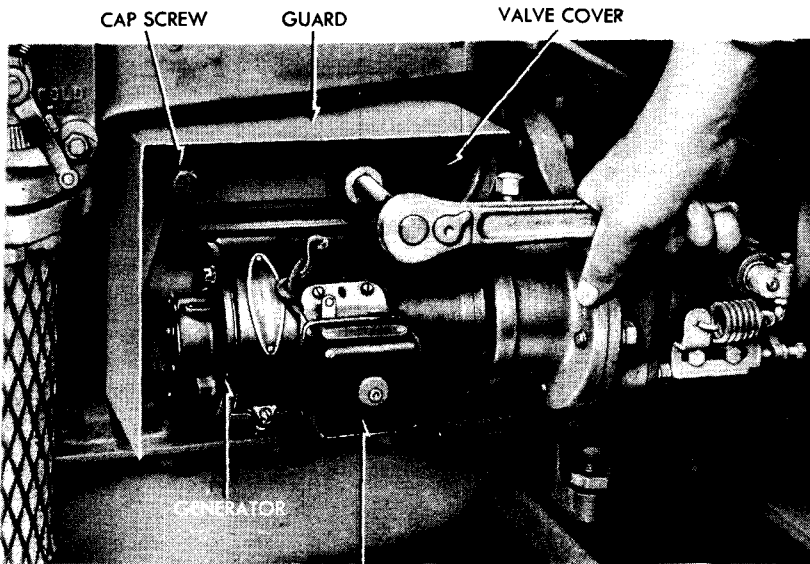

TWO CHARGE REGULATOR

RA PD 78061

Figure 53 – Battery-charging Generator Guard Removal

leaves the brush. The tension for all three brushes, when new, should not be more than 53 ounces maximum.

(c) The charging rate of the generator is controlled by a third brush that is adjustable. Advance or retard the third brush as required. Moving the brush in direction of rotation increases the charging rate, while moving it against armature rotation decreases the charging rate.

(3) **BRUSH REPLACEMENT** (fig. 52). **NOTE:** To avoid connecting the generator leads to the wrong brush holders, remove and install one brush at a time. Brush holder in line with the 2-charge regulator does not have any lead attached to it other than the brush lead. Center brush holder can be rotated slightly to facilitate removing brush lead screw.

(a) Remove generator (subpar. d, below).

(b) Loosen cover band screw and remove cover band.

(c) Take out screw attaching brush lead, hold back brush spring clip, and lift out brush.

(d) Place the proper new brush in its brush holder and fit to commutator (subpar. c, (2), above).

(e) Connect brush lead and generator lead to brush holder (**NOTE** step (3), above).

(f) Replace cover band and secure in position with cover band screw.

ENGINE ELECTRICAL SYSTEM

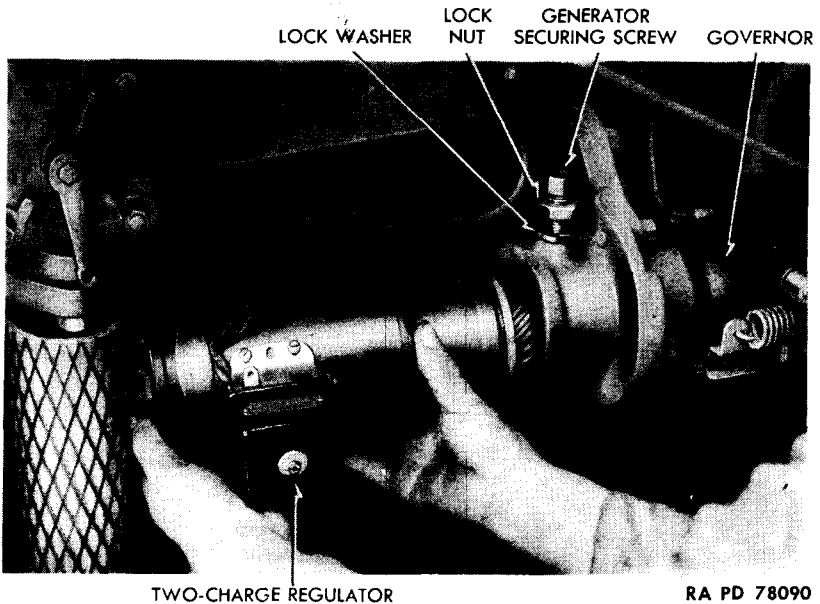

Figure 54 – Battery-charging Generator Removal

(g) Install generator (subpar. e, below).

d. Removal.

- (1) Unscrew cap screws securing generator guard and valve cover to engine block (fig. 53).
- (2) Remove screw attaching wire to 2-charge regulator terminal.
- (3) Loosen lock nut on generator securing screw that goes through generator housing to secure generator in place. Loosen generator securing screw until it is entirely clear of generator and lift out generator (fig. 54).

e. Installation.

- (1) Place generator into housing so that its gear meshes with camshaft timing gear, and 2-charge regulator faces opposite engine cylinder block (fig. 54).
- (2) Turn down on generator securing screw until tight and lock with lock washer (fig. 54). **NOTE:** Generator securing screw must enter dowel hole in generator body to secure generator in position properly. When turning down on generator securing screw, slightly rotate generator until screw is felt entering dowel hole.
- (3) Attach wire to 2-charge regulator terminal with screw and lock washer.
- (4) Install generator guard and valve cover and secure with two cap screws (fig. 53).

f. The 2-charge Regulator. A 2-charge regulator (voltage regu-

GENERATING UNIT M18

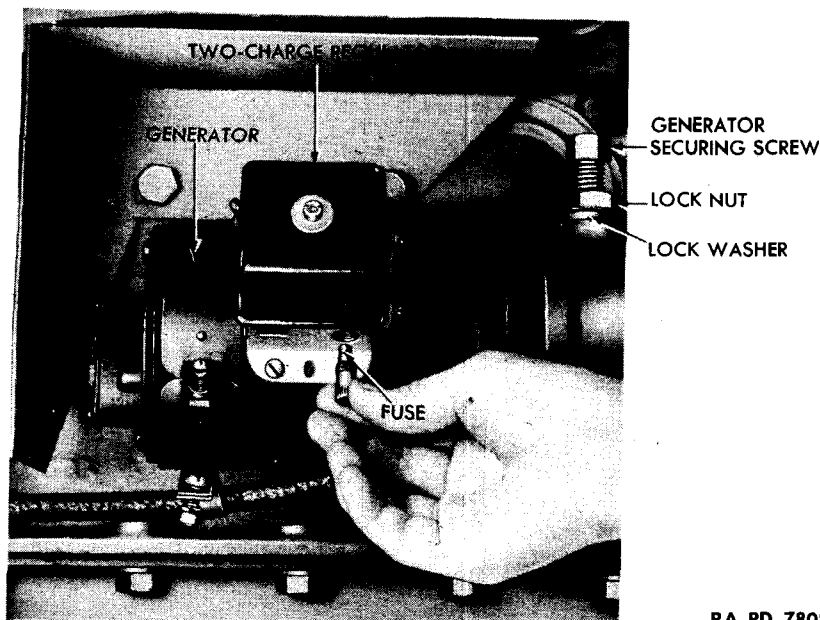

RA PD 78089

Figure 55 — 2-charge Regulator Fuse Removal

lator) is attached to the outside of the battery charging generator. Its function is dual. It opens the circuit and prevents the batteries from discharging back through the generator when the engine is stopped or running at low speed. It also cuts down the charging rate of the generator when the batteries are fully charged.

(1) **MAINTENANCE.** A fuse is held into a cavity on the under side of the regulator by a threaded cap. Its function is to prevent damage to the circuit in case of an overload due to a short circuit. When it burns out, the generator is rendered inoperative. Before replacing a burned-out fuse, inspect the circuit and repair damaged insulation or replace wires having poor insulation. To replace fuse, unscrew cap from under side of regulator. Fuse fits inside the cap and will be removed with the cap. Insert a new fuse in cap and screw cap into position on regulator.

(2) **REMOVAL.**

- (a) Disconnect "CG" wire from terminal on regulator.
- (b) Remove the four screws and lock washers which secure regulator to generator.
- (c) Disconnect the two wires from terminals on under side of regulator and lift regulator from generator.

(3) **INSTALLATION.**

- (a) Connect red field wire from generator to "F" terminal on under

ENGINE ELECTRICAL SYSTEM
IGNITION WRENCH

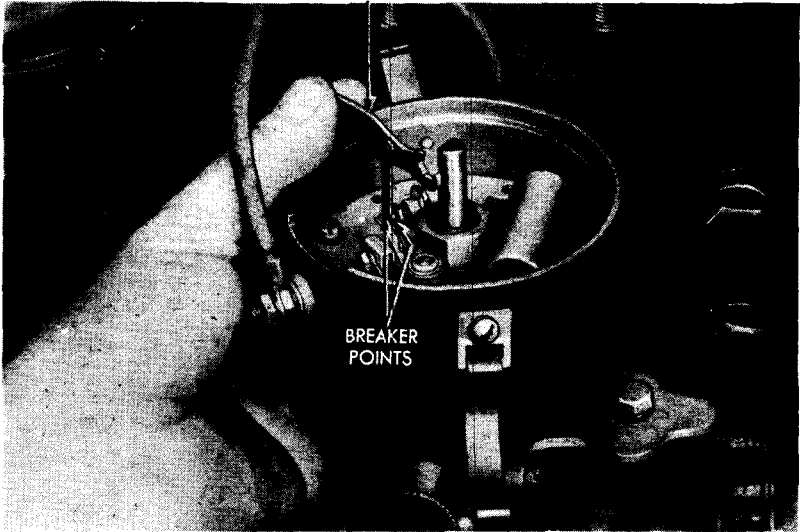

RA PD 78062

Figure 56 – Gaging Breaker Point Gap

side of regulator. Connect black armature wire from generator to “A” terminal of regulator.

(b) Position regulator on generator and install the four lock washers and screws.

(c) Connect “CG” wire (from terminal block) to terminal on side of regulator.

76. IGNITION COIL.

a. Construction. The ignition coil (fig. 14) consists of a primary and a secondary winding, mounted upon a common magnetic core.

b. Functioning. The ignition coil is a current transformer that takes the 12-volt current, and by induction, builds it up to the voltage required for the ignition spark.

c. Maintenance.

(1) The ignition coil is a totally enclosed unit that needs no special attention. Connections and terminals should be kept clean and tight.

(2) If coil is thought to be faulty, substitute another coil known to be in good condition, and check engine operation.

d. Removal.

(1) Remove two screws attaching ignition coil to ignition coil bracket and lift away coil.

(2) Pull out high-tension wire snap-on lead and disconnect leads from coil terminal posts. Remove coil.

GENERATING UNIT M18

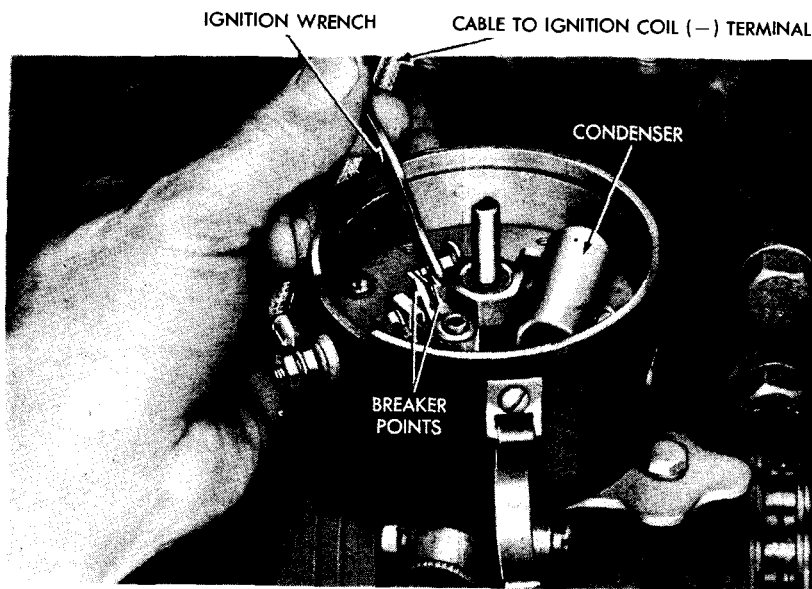

Figure 57 — Breaker Point Adjustment RA PD 78071

e. Installation.

(1) Connect lead of cable from ignition switch to “+” terminal post and lead of cable from distributor to “-” terminal post of ignition coil. Push snap-on lead, with high-tension wire attached, into center coil terminal.

(2) Place coil against mounting bracket and secure in position with two screws, nuts, and lock washers.

77. DISTRIBUTOR (fig. 56).

a. Construction. The distributor is a 6-cylinder, automatic, single breaker arm type which contains the battery circuit breaker points, automatic advance mechanism, and high-tension distributor. A condenser is set across the lines. A plate attached to the distributor body, directly beneath the distributor rotor, prevents moisture and dirt from entering the inside of the distributor body.

b. Functioning. The rotor makes contact between the spark plug connected points in the distributor cap and the ignition coil high-tension line. The breaker interrupts the current in the primary line of the ignition coil, which induces high-tension current in the secondary. The condenser cushions the shock of the interrupted current, and prevents burning of the breaker points.

c. Maintenance.

(1) **DISTRIBUTOR CAP.** The distributor cap must be kept clean and should be constantly inspected for cracks, carbon runners, evi-

ENGINE ELECTRICAL SYSTEM

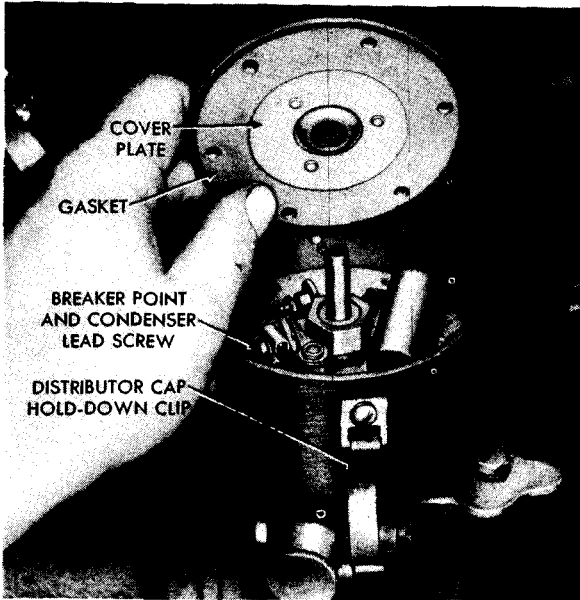

RA PD
78051

Figure 58 — Breaker Point and Condenser Cover Removal

dence of arcing, or corroded high-tension terminals. If any of these conditions is present, the cap should be replaced. After a distributor cap has had normal use, the inside of the cap inserts will become slightly burned. If these inserts are badly burned at any other point, the cap should be replaced. Check and replace brush in center of cap if found worn or broken. Brush must be free in cap so that spring beneath brush will hold it against rotor when cap is in position on distributor.

(2) **ROTOR.** The rotor should be inspected for cracks. If cracks are found, it should be replaced. After a rotor has had normal use, the end of the contact will become burned. If this burning is not excessive, and is found only on the end of the metal strip, the rotor need not be replaced. If burning is found on the top of the strip, it indicates the rotor is too short, and needs replacing. Usually when this condition is found, the distributor cap inserts will be burned on their horizontal face, and the cap also will need replacing.

(3) **BREAKER POINTS.** If breaker points are in good condition, they will show a grayish color with no evidence of burning or pitting. Breaker points should be so alined as to make contact over the whole area of the contact surfaces. Breaker point gap should be 0.020 inch \pm 0.002 inch (fig. 56). If alinement is not correct, bend the stationary point bracket to secure proper alinement, and then adjust the gap (fig. 57), and tighten the lock nut. Breaker point pressure

GENERATING UNIT M18

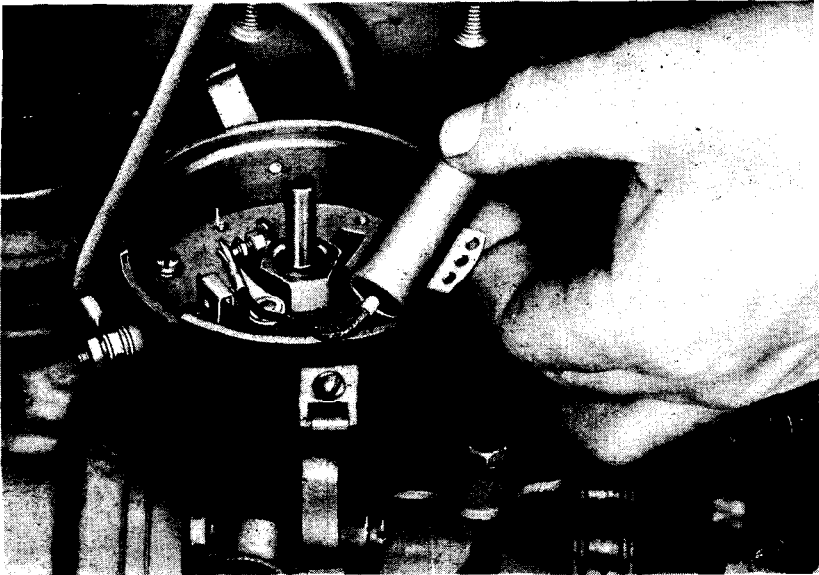

Figure 59 – Condenser Removal

RA PD 78067

should be 17 to 20 ounces. Check with spring scale hooked on the breaker arm at the point, and pull on a line perpendicular to the breaker arm. Take the reading just as the points separate. Adjust the point pressure by loosening the screw holding the end of the contact arm spring and sliding the end of the spring in and out as necessary.

(4) **CONDENSER.** The condenser (fig. 57) should be checked for broken wires, frayed insulation, and firm mounting. See that connections are clean and tight.

d. Condenser Removal.

(1) Snap down the two distributor cap hold-down clips and lift off distributor cap. **NOTE:** Do not remove any wires from the distributor cap.

(2) Lift rotor up from the shaft, and remove.

(3) Remove six machine screws from plate covering distributor points and condenser and lift out plate (fig. 58).

(4) Remove screw securing condenser lead and breaker arm to breaker plate terminal.

(5) Remove screw securing condenser to breaker plate, and lift out condenser (fig. 71).

e. Condenser Installation.

(1) Place condenser in position on breaker plate (fig. 59) in distributor, and secure with machine screw.

ENGINE ELECTRICAL SYSTEM

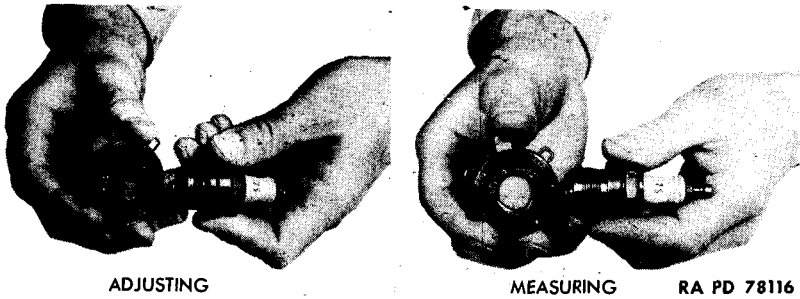

Figure 60 – Spark Plug Gap Adjustment

(2) Connect condenser lead to breaker plate terminal with screw securing breaker arm to breaker plate terminal.

(3) Place cover plate on distributor body over condenser and points (fig. 58), and secure in position with six machine screws.

(4) Place rotor in position over distributor shaft. Distributor shaft is cut so that it is possible to put rotor on shaft in one position only. Check position rotor is to be inserted to avoid breaking.

(5) Place distributor cap on distributor, and secure in position with the two distributor cap hold-down clips.

78. SPARK PLUGS.

a. Description. The spark plugs (fig. 60) are of the commercial automotive type with electrode gap adjustments made by bending the side electrode. Each plug consists of a metal shell within which is fixed an insulator with a central electrode stem. The metal shell is threaded to screw into the engine cylinder head. The central electrode stem is threaded at the upper part of the insulator to provide means of attaching the high-tension lead from the distributor. Champion No. 1 common, or equivalent spark plugs are used. These plugs are a cold-type, and under no circumstances should they be replaced with hot-type plugs.

b. Functioning. When the circuit from the ignition coil to the spark plug is closed, a spark jumps across the spark plug electrode gap and ignites the gas mixture in the combustion chamber.

c. Trouble Shooting. Cracked, dirty, or improperly adjusted spark plugs cause poor engine performance. To determine if faulty engine performance is caused by one or more faulty spark plugs, start engine and set speed slightly above idling. Short out each spark plug with a wood-handle screwdriver, by holding the screwdriver bit against the spark plug terminal and engine cylinder head. **NOTE:** Do not touch metal part of screwdriver as an unpleasant shock will be felt. If there is noticeable difference in the engine performance, the shorted spark plug can be assumed to be in good condition. If, however, there is no noticeable difference in engine performance, the

GENERATING UNIT M18

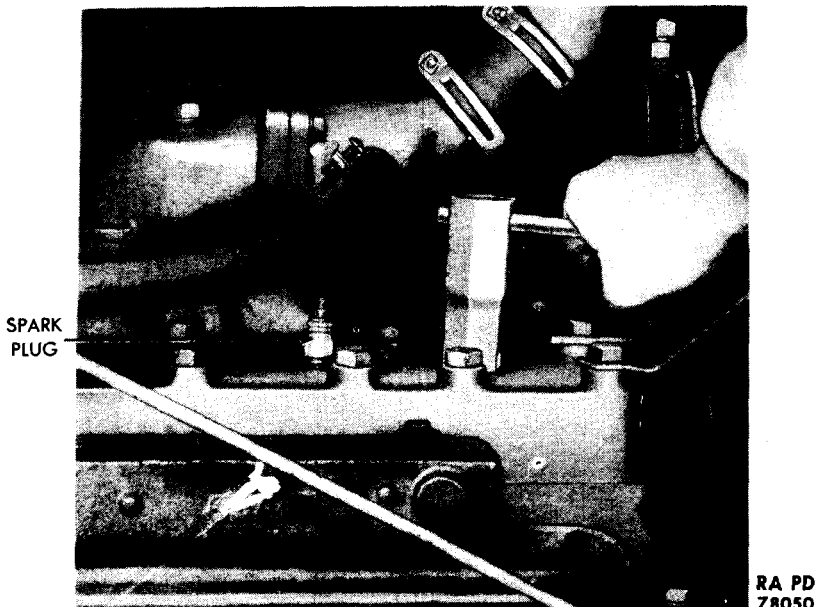

Figure 61 – Spark Plug Removal

shorted plug should be renewed. If the installation of new spark plugs does not improve engine performance, fault must be found elsewhere in the ignition system, in the fuel system, or a mechanical defect exists in the engine.

d. Maintenance. Remove spark plugs after each 100 hours of operation, and make the following check:

(1) Check for cracked or blistered insulations, and replace plugs if any is evident.

(2) Check for dirty electrodes and insulations. Thoroughly clean each dirty spark plug in sand blast spark plug cleaner.

(3) Check for worn electrodes. Replace spark plugs with worn electrodes.

(4) Check and adjust spark plug electrode gap using 0.025-inch feeler on gage (fig. 60). Bend outside electrode to obtain correct gap. Never bend center electrode.

(5) Test each spark plug on a spark plug tester to assure proper performance.

e. Removal. Unsnap high-tension lead from the spark plug terminal, and using a spark plug wrench (fig. 60), unscrew spark plug from cylinder head. Lift off spark plug gasket with spark plug.

f. Installation. Place copper gasket over threaded portion of the spark plug shell, and screw spark plug into cylinder using spark plug wrench (fig. 60). Avoid excessive pressure when tightening spark plugs. Attach proper high-tension lead to spark plug terminal.

ENGINE ELECTRICAL SYSTEM

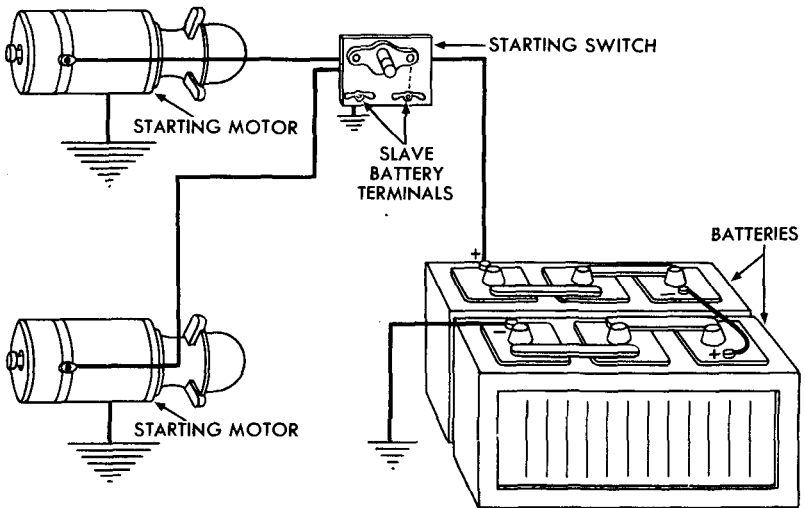

RA PD 78076

Figure 62 – Engine Starting System

79. STARTING MOTORS.

a. Construction. The starting or cranking motors are heavy-duty, 4-brush, Bendix drive type. One is secured to the lower left side while the other to the lower right side of the engine bell housing. The Bendix drive attached to the extended starting motor armature shaft transmits power to the engine flywheel ring gear. A removable head band gives access to commutator and brushes.

b. Functioning. As the motor starts, the Bendix gear moves into mesh with the flywheel ring gear, and rotates the engine flywheel and crankshaft. As soon as the engine starts to run, the Bendix gear retracts until it is out of mesh with the flywheel ring gear.

c. Maintenance. The head band should be removed periodically, and the brushes and commutator inspected. If brushes wear excessively, check for excessive brush spring tension and for roughness or high mica of the commutator. Check for loose flange mounting screws and oil seepage into the drive from the engine bell housing.

d. Removal (fig. 63). NOTE: Procedure the same for either starting motor.

(1) Remove nut attaching starter switch wire lead to post on the frame of the starting motor.

(2) Take out three cap screws and lock washers holding starting motor to engine bell housing and lift off starting motor.

e. Installation (fig. 63).

(1) Place starting motor in position on engine bell housing, securing it with the three cap screws and lock washers.

GENERATING UNIT M18
RIGHT-HAND STARTING MOTOR

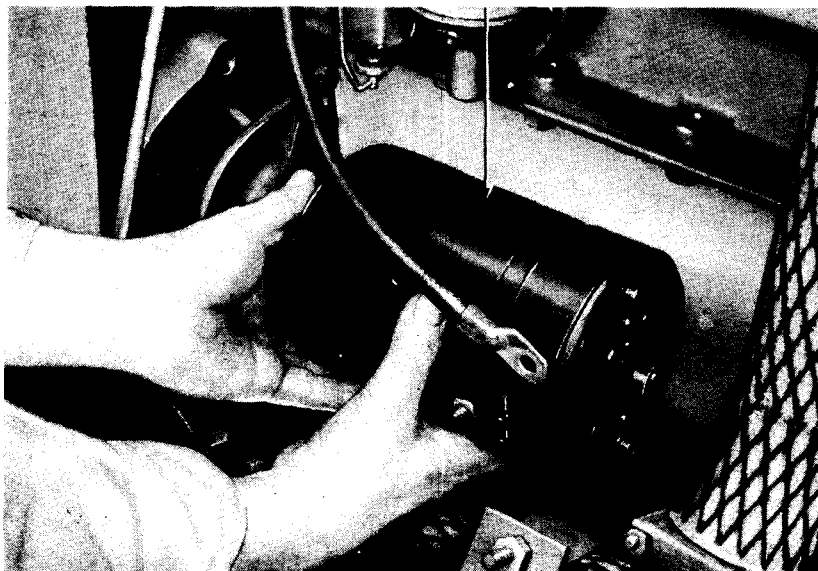

Figure 63 – Starting Motor Removal

RA PD 78059

(2) Bring lead from starter switch wire to post on frame of starting motor, and attach with nut provided.

f. Bendix Spring Removal (fig. 64).

- (1) Remove starting motor (subpar. d, above).
- (2) Loosen head band clamp screw, and remove head band.
- (3) Remove the two frame screws, and pull pinion housing and armature from starting motor frame. Do not separate commutator end head from frame.
- (4) Slide pinion housing from armature shaft.
- (5) Bend down the lip on each lock washer, and remove head spring screw and shaft spring screw.
- (6) Slide pinion assembly off armature shaft, and lift off Bendix spring.

g. Bendix Spring Installation (fig. 64).

- (1) Thoroughly clean Bendix drive parts in SOLVENT, dry-cleaning, and apply a few drops of OIL, engine, SAE 10, to armature shaft, pinion shaft, and armature shaft bearings.
- (2) Slide Bendix spring and pinion assembly in position over armature shaft. Using a lock washer (special) over each screw, secure spring to head and armature shaft, using head spring screw (doweled). NOTE: Doweled portion of head spring screw must enter hole in armature shaft. Secure spring to pinion assembly using shaft spring screw. Lock screws by bending up the lip on each lock washer.

ENGINE ELECTRICAL SYSTEM

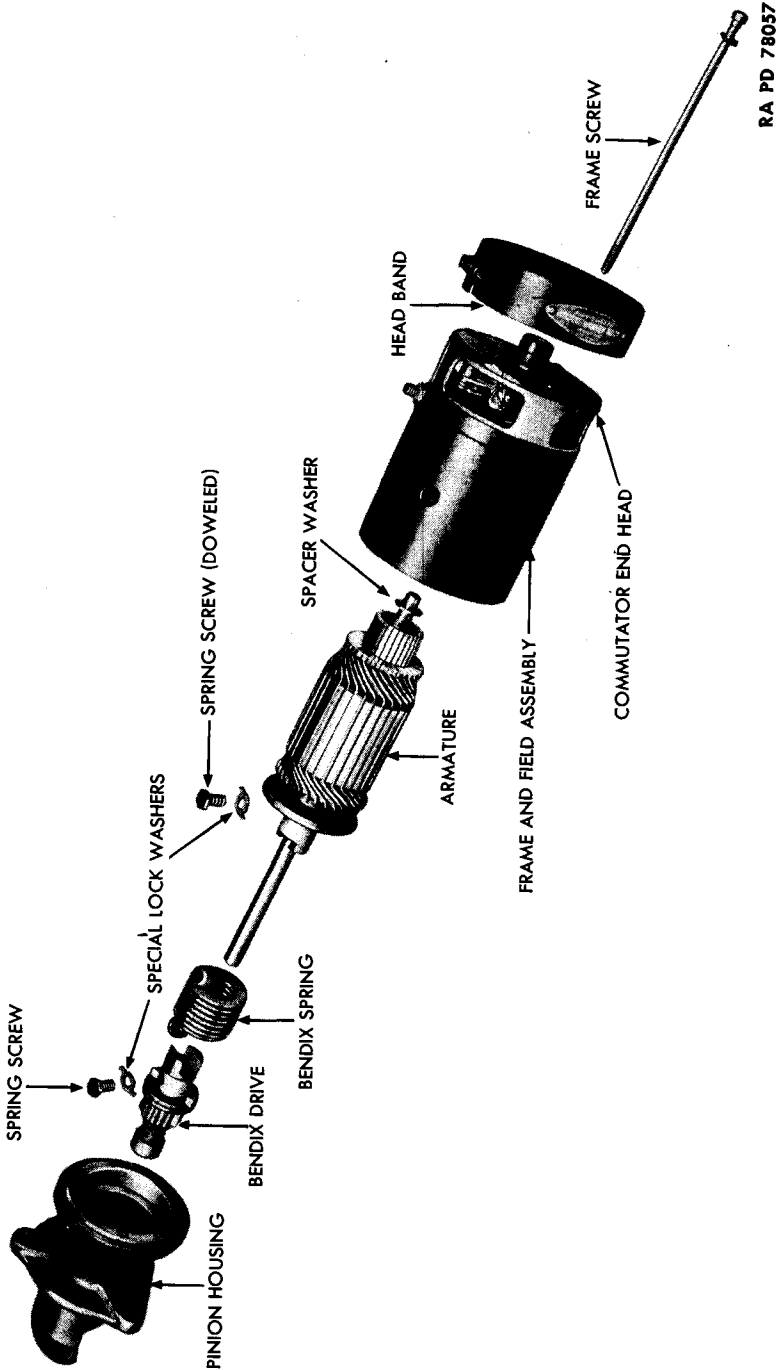
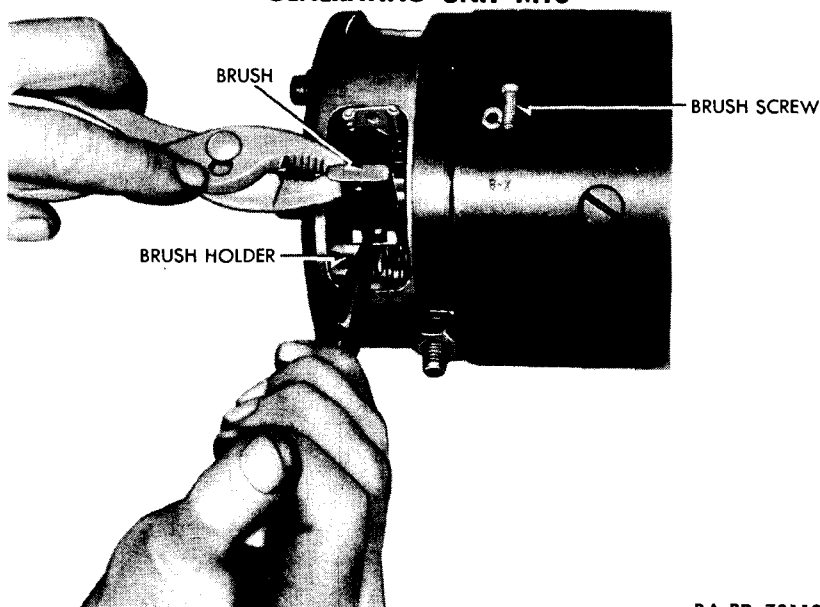

Figure 64 — Starting Motor Partially Disassembled to Remove Bendix Spring

GENERATING UNIT M18



RA PD 78119

Figure 65 – Starting Motor Brush Replacement

(3) Assemble armature shaft with attached Bendix drive assembly into pinion housing, so that intermediate bearing hub slot lines up with the dowel pin in housing. Push hub into position on housing. Rotate armature to test if the armature bearings are lined up. The armature should rotate freely.

(4) Lift up on the four brushes and, with spacer washer over shaft on commutator end of armature, push armature through starting motor frame, so that shaft enters end head bearing. Release brushes.

(5) Attach commutator end head and pinion housing to frame, using the two frame screws.

(6) Place head band over commutator end head, and secure in position with clamp screw.

(7) Install starting motor (subpar. e, above).

h. Brush Replacement (fig. 65).

(1) Remove starting motor (subpar. a, above).

(2) Loosen head band clamp screw and remove head band.

(3) Remove screws and lock washers securing brushes to brush holders and lift out brushes (fig. 65).

(4) Slip new brushes in position and attach to brush holders with screws and lock washers.

(5) Replace head band and secure with clamp screw.

(6) Install starting motor (subpar. e, above).

ENGINE ELECTRICAL SYSTEM

i. Starter Switch.

(1) The starter switch, attached to a bracket adjacent to the lower left corner of the instrument panel, is a conventional automotive push-button type switch.

(2) REMOVAL.

(a) Disconnect the four wires and one copper strip from the two switch terminals.

(b) Remove the two nuts, lock washers, and bolts which secure switch to bracket and remove switch from bracket.

(3) INSTALLATION.

(a) Position switch on under side of bracket with push button extended up through hole in bracket. Install the two bolts, lock washers, and nuts which attach switch to bracket.

(b) To terminal toward engine connect the two wires which lead to starting motors. These wires are marked with red paint at time of assembly of unit at factory.

(c) To terminal away from engine connect wire from battery, wire to ammeter, and copper strip from slave battery terminal.

j. **Slave Battery Terminals.** Two terminals are provided on the starter switch bracket. Their function is to make it easy to connect an additional 12-volt battery to aid in cold weather starting. Each terminal consists of a steel stud, two flat steel washers, two hexagonal nuts, and a wing nut. In addition, the left-hand terminal is equipped with two flat fiber insulating washers and a tubular fiber insulating bushing.

(1) REMOVAL.

(a) Remove left-hand terminal as follows: Screw nut from under side of terminal. Remove flat washer, copper strip, insulating washer, and insulating bushing from under side of terminal. Lift terminal, flat washer, and insulating washer from top of bracket.

(b) Remove right-hand terminal as follows: Remove nut and flat washer from under side of terminal. Lift terminal and flat washer from top of bracket.

(2) INSTALLATION.

(a) Install left-hand terminal as follows: Install insulating washer, flat washer, hexagonal nut, and wing nut on top of stud. Insert lower end of stud into left-hand hole in starter switch bracket. On lower end of stud, install insulating bushing, insulating washer, copper strip, flat washer, and hexagonal nut.

(b) Install right-hand terminal as follows: Install flat washer, hexagonal nut, and wing nut on top of stud. Insert lower end of stud through right-hand hole in starter switch bracket. On lower end of stud, install flat washer and hexagonal nut.

GENERATING UNIT M18

RA PD 15686

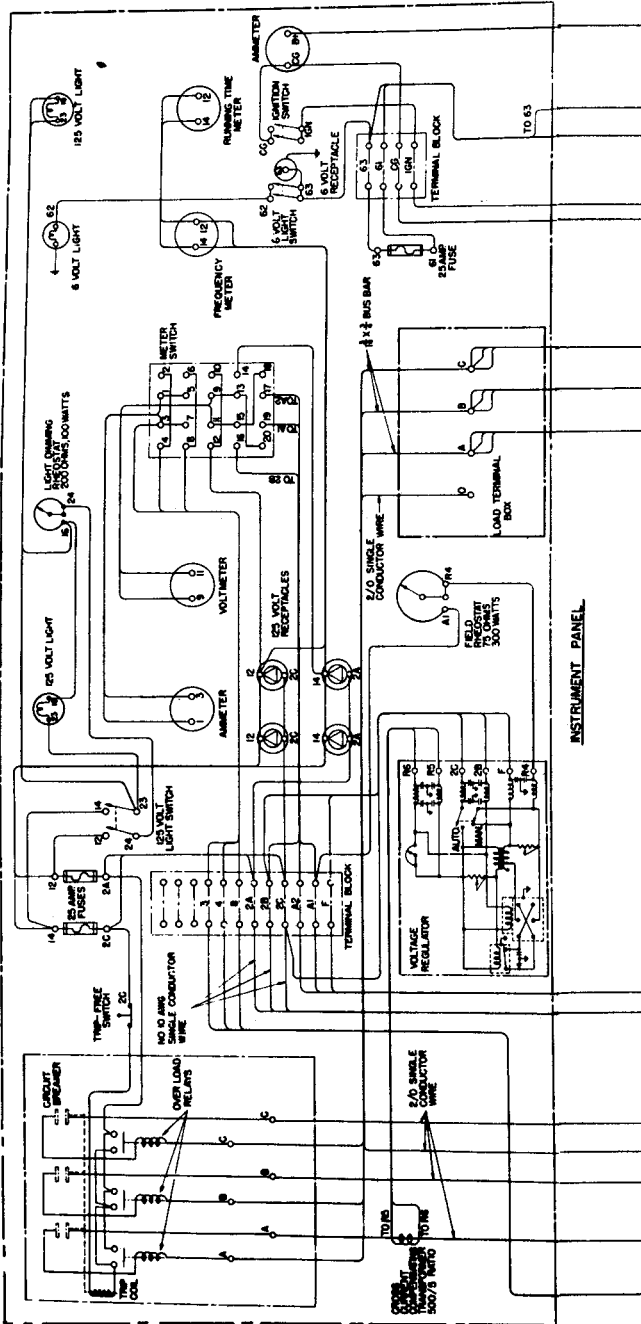

ENGINE ELECTRICAL SYSTEM

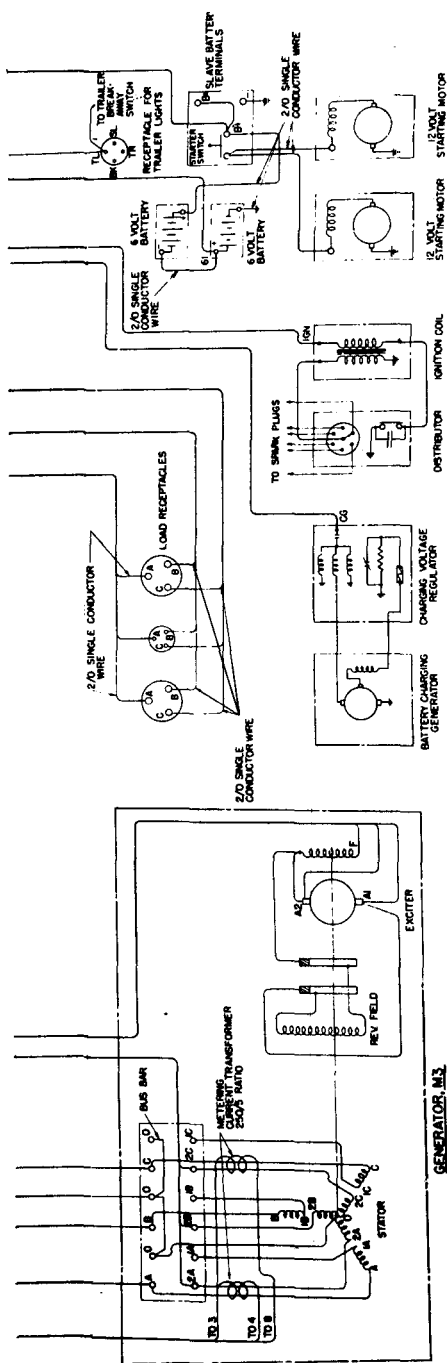

SMALL WIRE COLOR CODE
 LINE A - RED TRACE
 LINE B - GREEN TRACE
 LINE C - BLUE TRACE
 LINE D - BLACK TRACE
 LINE E - WHITE TRACE
 LINE F - BLACK TRACE
 LINE G - WHITE TRACE
 LINE H - WHITE TRACE
 LINE I - WHITE TRACE
 LINE J - WHITE TRACE
 LINE K - WHITE TRACE
 LINE L - WHITE TRACE
 LINE M - WHITE TRACE
 LINE N - WHITE TRACE
 LINE O - WHITE TRACE
 LINE P - WHITE TRACE
 LINE Q - WHITE TRACE
 LINE R - WHITE TRACE
 LINE S - WHITE TRACE
 LINE T - WHITE TRACE
 LINE U - WHITE TRACE
 LINE V - WHITE TRACE
 LINE W - WHITE TRACE
 LINE X - WHITE TRACE
 LINE Y - WHITE TRACE
 LINE Z - WHITE TRACE
 NOTE: ALL WIRES TO BE NO. 16 AWG UNLESS OTHERWISE SPECIFIED.
 ALL WIRES TO BE NO. 16 AWG UNLESS OTHERWISE SPECIFIED.

METER SWITCH CONNECTIONS	POSITION A	POSITION B	POSITION C	POSITION D
1 TO 2	1 TO 2	1 TO 2	1 TO 2	1 TO 2
3 TO 4	3 TO 4	3 TO 4	3 TO 4	3 TO 4
5 TO 6	5 TO 6	5 TO 6	5 TO 6	5 TO 6
7 TO 8	7 TO 8	7 TO 8	7 TO 8	7 TO 8
9 TO 10	9 TO 10	9 TO 10	9 TO 10	9 TO 10
11 TO 12	11 TO 12	11 TO 12	11 TO 12	11 TO 12
13 TO 14	13 TO 14	13 TO 14	13 TO 14	13 TO 14
15 TO 16	15 TO 16	15 TO 16	15 TO 16	15 TO 16
17 TO 18	17 TO 18	17 TO 18	17 TO 18	17 TO 18
19 TO 20	19 TO 20	19 TO 20	19 TO 20	19 TO 20

RA PD 15686A

Figure 66 - Wiring Diagram Generating Unit M18

GENERATING UNIT M18

Section XV

GENERATING SYSTEM

	Paragraph
Description and operation	80
A-C generator description	81
A-C generator maintenance	82
200-ampere power receptacles	83
30-ampere power receptacle	84

80. DESCRIPTION AND OPERATION (fig. 66).

a. The generating system consists of the following units: a-c generator, exciter field rheostat, circuit breaker or load switch, voltage regulator, voltmeter, ammeter, meter switch, two instrument light sockets with lamp-dimming rheostat, three power receptacles, load terminal box, four T-slot receptacles, and necessary fuses and wiring. The a-c generator, which is described in more detail in paragraph 81, consists of an exciter and alternator on a single shaft and enclosed in one housing. The exciter field rheostat is a conventional resistant-wire, circular-type unit. It is connected in the field circuit. The circuit breaker or load switch is composed of three overload relays, three circuit breakers, and a trip coil. It is connected in the "A," "B," and "C" leads from the stator of the alternator. The voltage regulator consists of both spring-loaded, magnetic units and a manually controlled unit. It is connected in the exciter field circuit in series with the field rheostat. The voltmeter and ammeter are of conventional design. They are connected into stator circuit of the alternator through the meter switch. This switch is provided to enable the operator to test the output in any of the three phases and also the output from the exciter. All sockets, receptacles, and the load terminal box (fig. 67) are connected into the stator circuit. They serve as the means of connecting to the generator. The lamp-dimming rheostat, similar in construction to exciter field rheostat but smaller, is connected in series with the two 125-volt instrument panel lights.

b. Directly coupled to the generator shaft, the engine turns the exciter armature and the field coils of the alternator. Direct current to excite the alternator field coils is supplied by the exciter as required by the load. The manually operated exciter field rheostat (fig. 7) is used to maintain constant a-c output under varying loads when the voltage regulator switch is in "OFF" position. The voltage regulator (fig. 7) is designed to hold voltage variation to within ± 2 percent from full load to no load operation. For automatic voltage regulation, the voltage regulator switch must be in "ON" position and the field exciter rheostat turned all the way to the right or in a clockwise direction. The circuit breaker serves a dual purpose. It is used as

GENERATING SYSTEM

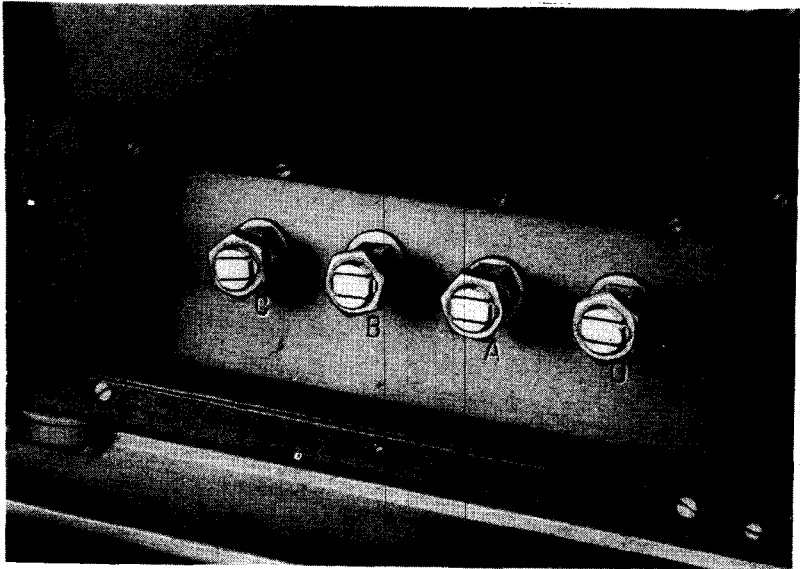

RA PD 78077

Figure 67 – Load Terminal Box

the main switch, manually to turn on and off the current supplied at the three outlet receptacles and the load terminal box. It also serves to turn off the current automatically in case of an overload which might damage the generator or engine by causing them to exceed rated capacity. An emergency overload switch (fig. 7) provides for operating the unit at an overload. All receptacles and sockets are fed from the circuit ahead of the circuit breaker and consequently are not controlled by the circuit breaker. Receptacle and socket circuits are protected by 25-ampere fuses located on the rear of the instrument panel. The 125-volt instrument panel lights are controlled by a toggle switch, and the amount of illumination given by them is controlled by the lamp-dimming rheostat (fig. 7).

81. A-C GENERATOR DESCRIPTION.

a. **Construction** (figs. 68 and 69). This generator consists of two generators mounted on the same shaft in the same housing. The smaller of the two, the exciter, is a direct-current stationary field type generator. Its purpose is to furnish direct current to excite the field windings of the larger generator, the alternator. The alternator is an alternating-current, revolving field type generator. Its function is to deliver the electrical output of the unit. The exciter is to the rear of the generator, while the alternator is to the front. Fans on each end of the shaft draw air through the windings to provide cooling. This M3 Generator is a 3-phase, 3KVA, alternating-current, 60-cycle

GENERATING UNIT M18

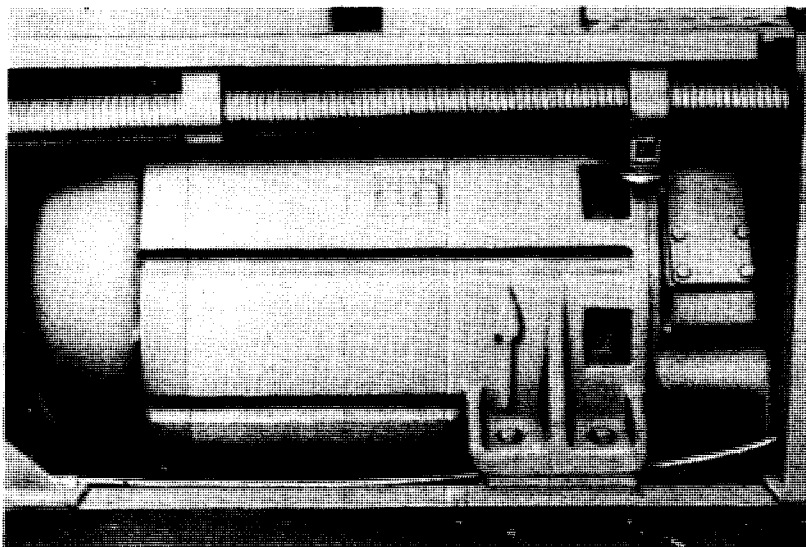

RA PD 78060

Figure 68 – Generator Installed – Right Side

type. At 1,200 rpm, it produces either 125-volt or 250-volt current, depending on how the links are connected in the generator terminal box. During 125-volt operation, it normally delivers up to 165 amperes. At 250 volts, its maximum normal capacity is 85 amperes. It is capable of delivering an overload for limited periods without damaging the generator. However, overload operation does overwork the engine and should be avoided except when absolutely necessary.

b. Functioning. For ordnance use, only the 125-volt output is employed. The current is obtained from the generator which converts the mechanical energy of the engine into electrical energy by means of magnetic induction. When driven at its rated speed, 1,200 rpm, the generator produces a voltage at its terminals equivalent to that provided by a usual 125-volt lighting circuit. This voltage can be varied over a range of 90 to 150 volts by use of the exciter field rheostat.

82. A-C GENERATOR MAINTENANCE.

a. Brush Inspection. At least once every 3 months, remove brush covers (subpar. e, below) and visually inspect brushes (fig. 71). If gummy or stuck in their holders, remove and clean brushes. Clean all dirt from the brush holders. Check tightness of all pigtail connections.

b. Collector Ring Inspection. Inspect collector rings whenever brush covers are removed for servicing brushes and brush holders. (To remove covers, see subpar. e, below.) Note condition of surface

GENERATING SYSTEM

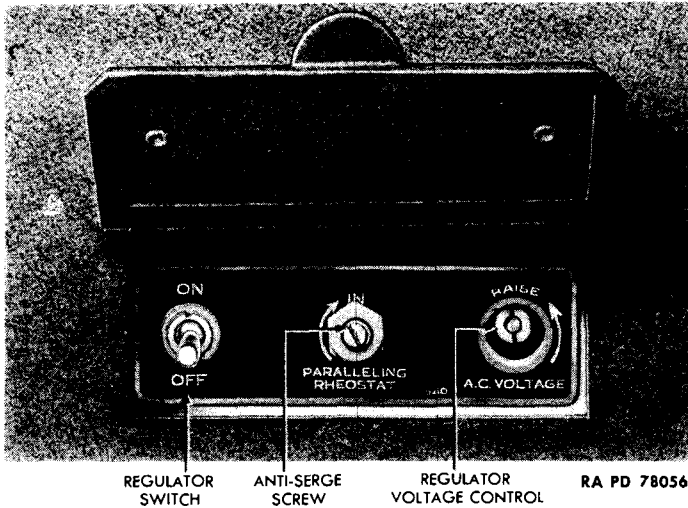

Figure 69 – Voltage Regulator Adjustment Facilities

of rings. Surface should appear smooth and clean. Scoring or roughening of collector ring surfaces may be caused by grit or abrasive in brushes, or by presence of oil on rings. Moderately rough collector rings can be corrected by holding PAPER, flint, class B, No. 00, to their surfaces while the rings are revolving. If rings are badly scored or worn, report to higher authority. After cleaning collector rings, blow out dirt and grit with compressed air.

c. Commutator Inspection. Inspect exciter commutator whenever brush covers are removed. (To remove covers see subpar. e, below.) All bars should appear smooth and clean. If commutator appears moderately rough or dirty, clean by holding PAPER, flint, class B, No. 00, against it while it is slowly revolving. Badly scored commutators or commutators with uneven bars must be reported to higher authority. Blow out dirt and grit from generator with compressed air. **NOTE:** Never use oil or CLOTH, abrasive, aluminum-oxide, on commutators.

d. Brush Spring Inspection. Collector ring brush springs are designed to give a minimum pressure of 8 ounces per brush. This pressure is not critical on collector rings, and spring pressure will be maintained indefinitely unless brush pigtail circuit opens and the current is carried through the spring. If so, spring will lose its temper and must be replaced. Commutator brush springs are designed to give a pressure of 12 to 14 ounces. It is important to maintain this

GENERATING UNIT M18

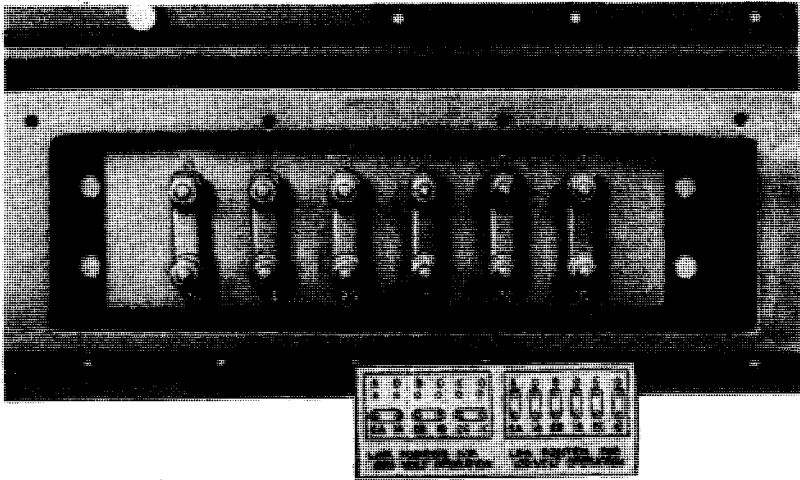

CHANGE-OVER DIAGRAM

RA PD 78088

Figure 70 – Generator Terminal Box

pressure within these limits. To measure spring tension pressure, hook spring scale under spring lever at point which lever bears on brush. Pull directly away from collector ring or commutator. Take reading with lever just lifted from brush. Spring tension can be adjusted to obtain the proper scale reading by changing the position of the spring eye in the spring adjusting holder.

e. Brush Removal (fig. 71).

- (1) Disconnect wire attached to trailer brake receptacle.
- (2) Unscrew nuts and screws securing generator panel to frame and remove panel.
- (3) Remove cap screws securing fan guard to generator frame. Separate fan guard by removing the attaching cap screws and nuts and lift the halves of the guard from the unit.
- (4) Using socket-head screw wrench, loosen socket-head screws and lift out brush covers.
- (5) Remove screws securing brush pigtail connections to brush holders and lift out brushes.

f. Brush Installation. When replacing brushes, it is important that they are carefully fitted to the commutator or collector rings. To fit brushes, slip a piece of PAPER, flint, class B, No. 00, between brush and commutator or collector ring with flint surface facing brush. The paper must be of the same width as the commutator or slip ring. Following the curved surface of the commutator or slip ring, move the flint paper back and forth until the proper brush surface is obtained. Procedure for brush installation is the reverse of subpar. e, above.

GENERATING SYSTEM

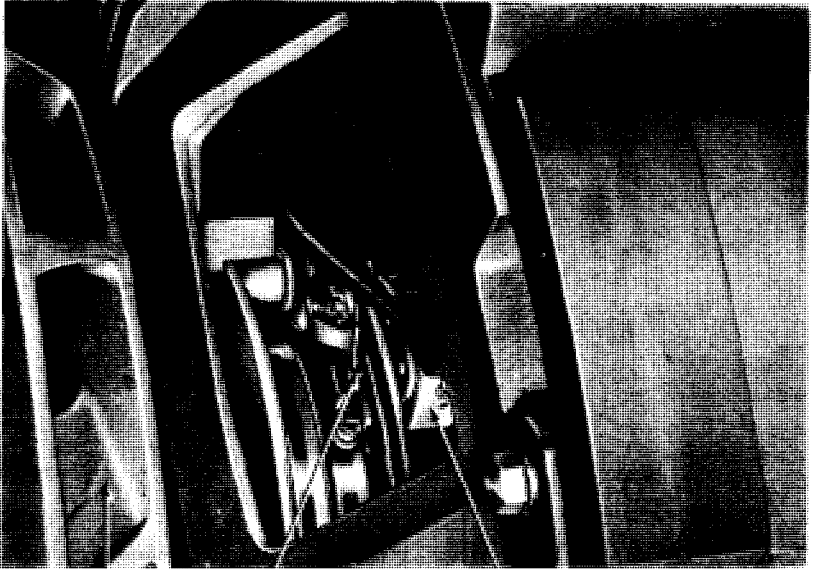

FAN

SLIP RING BRUSH

EXCITER BRUSH HOLDER

RA PD 78079

Figure 71 – Generator Brushes

83. 200-AMPERE POWER RECEPTACLES.

a. **Description.** The two larger receptacles (fig. 2) on the left side of the unit are 200-ampere, 3-pole power receptacles. They are of gooseneck type and are equipped with a chained cap for protection when not in use.

b. **Maintenance.** Keep receptacle mounting screws tight at all times. When not in use, keep receptacles tightly covered with cover furnished for the purpose.

84. 30-AMPERE POWER RECEPTACLE.

a. **Description.** The small receptacle (fig. 2) mounted between the two 200-ampere power receptacles, is a 30-ampere power receptacle. It also is of gooseneck type, and is provided with a chained cap for protection when not in use.

b. **Maintenance** (par. 83 b, above).

GENERATING UNIT M18

Section XVI
INSTRUMENT PANEL AND INSTRUMENTS

	Paragraph
General	85
Instrument panel	86
Battery-charging ammeter	87
Oil pressure gage	88
Temperature gage	89
Running time meter	90
Frequency meter	91
Voltmeter	92
Ammeter	93
Field rheostat	94
Ignition switch	95
125-volt light receptacle	96
125-volt light switch	97
Lamp-dimming rheostat	98
6-volt light receptacle	99
6-volt light switch	100
6-volt extension cord receptacle	101
Throttle control	102
Choke control	103
T-slot receptacle	104
Terminal blocks	105
Fuse blocks	106

85. GENERAL.

a. Only those instruments and controls which require maintenance by the using arms are mentioned in this section. For a description of all units mounted on the instrument panel, refer to section II of this manual.

b. All connections to instruments and all instrument attaching screws must be kept tight at all times. The only other maintenance required of the using arms is replacement of units the removal and installation of which is given below.

86. INSTRUMENT PANEL (figs. 7 and 72).

a. **Construction.** The instrument panel is of sheet-steel, and is located behind the instrument panel door at the left rear of the unit above the a-c generator. It is held in place by four rubber cushioned brackets.

b. **Functioning.** The instrument panel carries all the controls and gages necessary to the starting, stopping, and general operation and control of the unit, with the exception of the starter switch, slave bat-

INSTRUMENT PANEL AND INSTRUMENTS

tery terminals, and fuel gage. Starter switch and slave battery terminals are located on a bracket adjacent to the lower left corner of the instrument panel.

c. **Maintenance.** Keep mounting brackets and instruction plate and instrument attaching screws tight at all times. Replace rubber washers in mounting brackets whenever inspection shows them to be damaged.

87. BATTERY-CHARGING AMMETER.

a. **Description.** The battery-charging ammeter (figs. 7 and 72), in the upper left-hand corner of the instrument panel, below the oil pressure gage, indicates the charge and discharge currents of the two 6-volt batteries.

b. Removal.

- (1) Disconnect wires from terminals on rear of ammeter.
- (2) Remove nuts and star washers holding bracket against the rear of the panel, and remove bracket clips. Remove ammeter.

c. Installation.

- (1) Insert ammeter through the face of the instrument panel, and attach bracket clips over studs with nuts and star washers.
- (2) Attach two wires marked "CG" to front connection, and wire marked "B" to rear connection, with elastic stop nuts.

88. OIL PRESSURE GAGE.

a. **Description.** The oil pressure gage (figs. 7 and 72) is at the extreme upper left on the instrument panel. It is of the automotive type, and indicates pounds pressure per square inch. With the engine running at 1,200 rpm, the gage should indicate approximately 25 pounds pressure, if the engine is fully warmed up.

b. Removal.

- (1) Take nuts from inverted flare tube fitting at back of gage (fig. 72), and remove line from instrument.
- (2) Take nuts and star washers from bracket. Remove bracket and gage.

c. Installation.

- (1) Insert gage through face of instrument panel. Secure gage to panel with bracket attached to studs by nuts and star washers.
- (2) Connect oil line from base of oil filter to inverted flare tube fitting.

89. TEMPERATURE GAGE.

a. **Description.** The temperature gage (figs. 7 and 72) is located on left-hand side of the instrument panel. It indicates the temperature of the water in the engine. This should be maintained at between 160 F and 180 F, while operating generating unit.

GENERATING UNIT M18

RA PD
78092

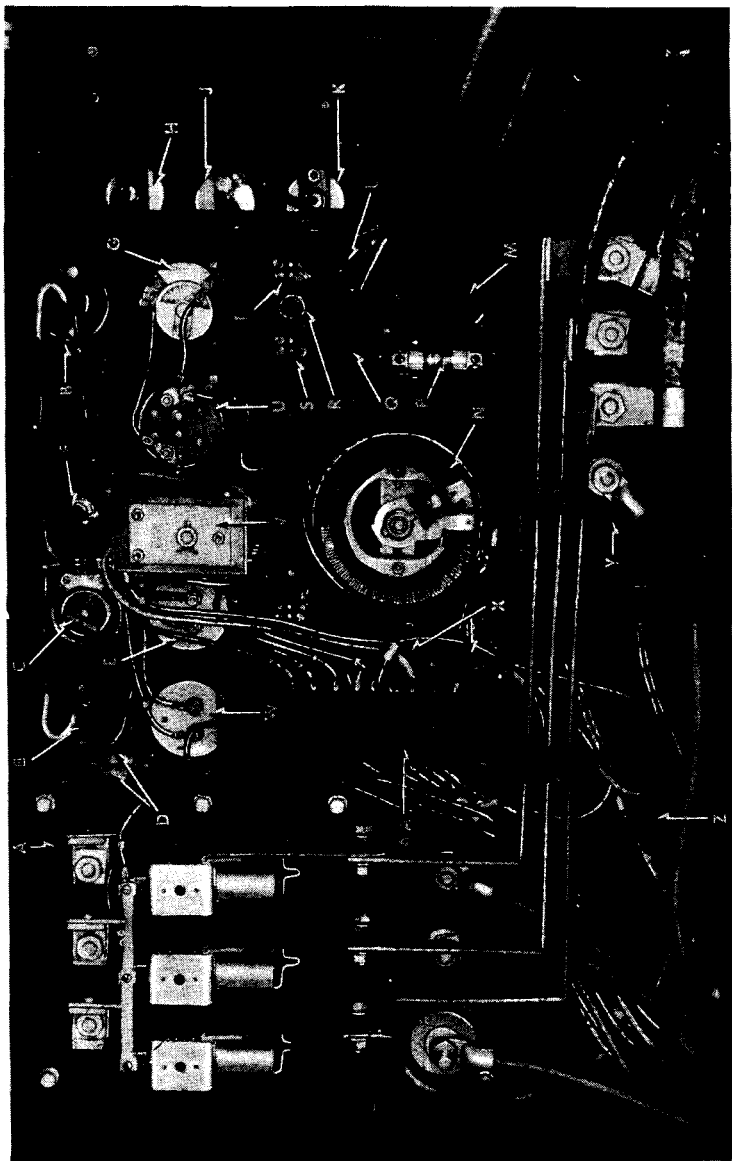

Figure 72 — Instrument Panel — Rear View

INSTRUMENT PANEL AND INSTRUMENTS

- | | |
|--------------------------------------------|----------------------------------|
| A —BREAKER PANEL ASSEMBLY | N —EXCITER FIELD RHEOSTAT |
| B —125-VOLT INSTRUMENT LIGHT SOCKET | P —25-AMPERE FUSE |
| C —125-VOLT LAMP DIMMER | Q —CHOKE |
| D —25-AMPERE FUSES | R —6-VOLT RECEPTACLE |
| E —VOLTMETER | S —6-VOLT LIGHT SWITCH |
| F —6-VOLT INSTRUMENT LIGHT SOCKET | T —IGNITION SWITCH |
| G —RUNNING TIME METER | U —FREQUENCY METER |
| H —OIL PRESSURE GAGE | V —METER SWITCH |
| J —BATTERY CHARGING AMMETER | W —AMMETER |
| K —TEMPERATURE GAGE | X —125-VOLT RECEPTACLES |
| L —THROTTLE | Y —LOAD TERMINAL BOX |
| M —TERMINAL BLOCK | Z —VOLTAGE REGULATOR BOX |
| | AA —TERMINAL BLOCK |

RA PD 78092A

Legend for Figure 72 — Instrument Panel — Rear View

GENERATING UNIT M18

b. Removal.

- (1) Unscrew temperature indicator bulb from engine head.
- (2) Unwrap tape which attaches line to oil line.
- (3) Take off nuts and star washer holding bracket to panel, and remove gage.

c. Installation.

- (1) Insert gage in instrument panel, and install bulb at end of gage line in tapped hole in engine head.
- (2) Secure gage to instrument panel by attaching bracket over studs with nuts and star washers.
- (3) Tape line to oil line to stop vibration.

90. RUNNING TIME METER.

a. Description. Located to the left of the instrument panel adjacent to the oil pressure gage and battery charging ammeter, is a running time meter (figs. 7 and 72). It is an electrically operated instrument which records, in hours, the running time of the unit. In operation and construction, it is similar to an electric clock.

b. Removal.

- (1) Disconnect the two wires from the two terminals on the rear of the instrument.
- (2) Remove the three nuts, lock washers, and bolts which attach meter to panel. Lift meter from front of instrument panel.

c. Installation.

- (1) Position meter on panel and install the three bolts, lock washers, and nuts which hold meter to panel. Connect red wire from frequency meter to bottom terminal.
- (2) Connect blue wire from frequency meter to top terminal.

91. FREQUENCY METER.

a. Description. The frequency meter (figs. 7 and 72) is located to the right of the running time meter. It is a vibrating reed type instrument and registers the number of cycles at which the current is alternating. Its range is from 57 to 63 cycles.

b. Removal.

- (1) Disconnect all four wires from the two terminals on the rear of the meter.
- (2) Remove the three nuts, lock washers, and bolts which attach meter to panel. Lift instrument from front of panel.

c. Installation.

- (1) Position meter in panel and install the three bolts, nuts, and lock washers which secure instrument to panel.
- (2) Connect the two red wires to front terminal and the two blue wires to the rear terminal on the back of the instrument.

INSTRUMENT PANEL AND INSTRUMENTS

92. VOLTMETER.

a. **Description.** The voltmeter (figs. 7 and 72), just right of the meter switch on the instrument panel, indicate the voltage of the exciter current and the voltage of the current generated by the unit, which is normally 125 volts for ordnance work. At this point on the dial is a red line. Black figures on the face of the instrument cover a range of 0 to 150 volts. Duplicate figures in red ranging from 0 to 300 volts, are used on 250-volt operation only. For procedure in obtaining these readings, see paragraph 7 c, and figures 8 and 9.

b. Removal.

(1) Remove the two leads from the two terminals on rear of instrument.

(2) Remove the three nuts, lock washers, and bolts which attach meter to panel. Lift instrument from front of panel.

c. Installation.

(1) Hold voltmeter on face of instrument panel with mounting holes in meter over mounting holes in panel. Insert bolts through holes. Install lock washers and nuts on the three bolts.

(2) To the front connection post, attach lead marked "11." To the rear post attach lead "9." Screw on elastic stop nuts.

93. AMMETER.

a. **Description.** The ammeter (figs. 7 and 72) is located on the instrument panel to the right of voltmeter. The ammeter indicates the amperage of the current delivered in the phases of the circuit. Two sets of figures appear on the face of the instrument. The red figures cover a range of 0 to 125 amperes and are used on 250-volt operation. Black figures, ranging from 0 to 250 amperes are used for 125-volt operation. See paragraph 7 c, and figure 9.

b. Removal.

(1) Disconnect both leads from terminals on back of meter.

(2) Remove the three nuts, lock washers, and bolts which attach ammeter to panel and lift instrument from front of panel.

c. Installation.

(1) Hold ammeter on face of panel with mounting holes in meter over mounting holes in panel. Insert bolts through holes. Hold bolts, and install lock washers and nuts on bolt ends.

(2) To the front connection post, attach lead marked "3." To the rear post attach lead marked "1."

94. FIELD RHEOSTAT.

a. **Description.** The field rheostat (figs. 7 and 72) is located toward the bottom of the instrument panel, just left of center. It controls the output voltage of the unit. To increase the voltage of the current delivered, the knob is turned clockwise. The minimum

GENERATING UNIT M18

voltage position, which is also the starting and stopping position, is with the knob turned counterclockwise as far as possible.

b. Removal.

(1) Disconnect leads from binding posts at rear of rheostat by removing nuts and lock washers.

(2) Take out vertical screw holding rheostat knob to shaft, and remove knob.

(3) Take out two screws and lock washers on the face of the instrument panel holding rheostat to panel.

c. Installation.

(1) Attach rheostat to instrument panel with lock washers and screws through panel into rheostat tapped holes.

(2) Slip knob over rheostat shaft, and secure to shaft with vertical screw.

(3) Attach lead marked "A-1" to the rear binding post of the rheostat, and secure with nut and lock washer. Attach lead marked "F" to center post of rheostat, and install a wire jumper from center post to front post. Secure with nuts and lock washers.

95. IGNITION SWITCH.

a. Description. The toggle-type, single-pole, single-throw ignition switch (figs. 7 and 72) is at the upper left in the control group on the left side of the instrument panel. This switch controls the ignition system.

b. Removal.

(1) Take out screws holding down the two leads at the back of the switch, and remove leads.

(2) Remove ring nut from switch on front of instrument panel. Remove switch from rear of panel.

c. Installation.

(1) Set switch in position on rear of panel with neck projecting through hole. Screw on ring nut so it is just flush with edge of neck. In back of the panel, screw nut tightly against panel.

(2) Remove screw connectors from switch. To one pole of switch, connect lead marked "IGN." To the other pole, connect lead "CG." Replace the screws.

96. 125-VOLT LIGHT RECEPTACLE.

a. Description. At the top of the instrument panel are two 125-volt rubber-mounted light receptacles (figs. 7 and 72). They are controlled by the 125-volt light switch in the center of the panel, and the amount of the illumination given is regulated by the lamp-dimming rheostat set between them.

b. Removal.

(1) Trace lead "16" to lamp-dimming rheostat; remove nut and

INSTRUMENT PANEL AND INSTRUMENTS

lock washer, and remove lead. Trace lead "23" to 125-volt light switch; remove screw and lead.

(2) Hold screws, remove nuts and lock washers at back of instrument panel, and remove receptacle.

c. Installation.

(1) Bring receptacle to mounting holes in the front of the panel. Install with bolts through receptacle and panel, lock washers, and nuts at rear.

(2) Connect receptacle lead "16" to the left connection of the lamp-dimming rheostat. Secure with lock washer and nut. Connect receptacle lead "23" to the top left connection of the 125-volt light switch. Secure leads with screws.

97. 125-VOLT LIGHT SWITCH.

a. **Description.** The toggle-type, double-pole, single-throw, 125-volt light switch (fig. 7) is centrally located on the instrument panel below the voltmeter. This switch turns on the 125-volt lamps at the top of the panel.

b. **Removal** (par. 95 b).

c. Installation.

(1) Remove ring nut from switch. Set switch in position on panel with neck projecting through hole. Screw on ring nut so that it is just flush with edge of neck. In back of the panel, screw nut tightly against panel. Secure ring nut against front of panel.

(2) Remove screw connectors. To the top front connection, connect lead marked "14" (from fuse). To the top rear connection, bring lead marked "14" (from fuse). The lower front connection takes two leads marked "23" (from lights). The lower rear connection takes lead marked "24" (from lamp-dimming rheostat). Secure leads with screws.

98. LAMP-DIMMING RHEOSTAT.

a. **General.** Centrally located at the top of the instrument panel is the lamp-dimming rheostat (figs. 7 and 72), used to dim the 125-volt lamps.

b. Removal.

(1) Take off nuts and lock washers from connections on rear of rheostat. Remove the three leads.

(2) Take out screw through rheostat knob, and slide knob off.

(3) Unscrew nut holding rheostat shaft sleeve against the face of the panel, and slide rheostat out at the back of the panel.

c. Installation.

(1) Install rheostat at back of panel with shaft projecting through panel. Secure in place with nut on shaft sleeve set tight against face of panel.

GENERATING UNIT M18

(2) Twist knob on shaft, and secure by tightening screw through knob against flattened part of shaft.

(3) Install two leads marked "16" to the top connection on the rheostat. Install lead marked "24" on the center post. Connect link between center and lower terminals. Secure with lock washers and nuts.

99. 6-VOLT LIGHT RECEPTACLE.

a. Description. A 6-volt light receptacle (figs. 7 and 72) is located at the top of the instrument for use in illuminating the panel at times when the unit is not running and the 125-volt circuit cannot be used. This light is controlled by the toggle switch at the upper right in the control group above the choke button.

b. Removal.

(1) Loosen horizontal screw through the body of the receptacle, and remove lead from center of back.

(2) Unscrew nut from the tapped receptacle ring; remove lock washer and receptacle.

c. Installation.

(1) Insert receptacle through panel until rim holds it in place. Install lock washer and nut on back of receptacle.

(2) Insert lead wire "62" into connection hole at back of receptacle. Secure wire in place by tightening horizontal screw through body of receptacle.

100. 6-VOLT LIGHT SWITCH.

a. Description. The toggle-type, single-pole, single-throw, 6-volt light switch (figs. 7 and 72) is at the upper right in the control group on the left side of the instrument panel. This switch controls the 6-volt light which furnishes illumination when the unit is not running.

b. Removal. Follow procedure outlined in paragraph 95 b.

c. Installation.

(1) Remove ring nut from switch. Set switch in position on panel with neck projecting through hole. Screw on ring nut so that it is just flush with edge of neck. In back of the panel, screw nut tightly against panel. Secure ring nut against front of panel.

(2) Remove the screw connectors from the switch. To one pole connect lead marked "62." To the other pole connect two leads marked "63." Replace the screws.

101. 6-VOLT EXTENSION CORD RECEPTACLE.

a. Description. A receptacle (figs. 7 and 72) to take the 6-volt trouble light, which is carried in the tool box, is provided at top center in the control group.

b. Removal. Follow procedure outlined in paragraph 99 b.

INSTRUMENT PANEL AND INSTRUMENTS

c. Installation.

(1) Insert receptacle through panel until rim holds it in place. Install lock washer and nut on back of receptacle.

(2) Insert lead wire "63" into connection hole at back of receptacle. Secure wire in place by tightening horizontal screw through body of receptacle.

102. THROTTLE CONTROL.

a. **Description.** The throttle knob is at the lower left in the control group on the left side of the instrument panel (fig. 7). This knob has a wire connection (fig. 72) with a valve in the carburetor. Pulling out the knob reduces the amount of fuel mixture supplied the engine, and reduces engine speed.

b. Removal.

(1) Loosen clamping screws holding throttle wire to carburetor throttle lever arm, and remove wire from carburetor.

(2) Unscrew elastic stop nut from throttle knob casing on back of instrument panel, and remove nut. Remove knob, casing, and wire from the front of the instrument panel.

c. Installation.

(1) Insert throttle wire and casing through instrument panel hole until rim of knob casing holds against front of panel. Carry nut over wire, and tighten nut on threaded section of knob casing until the assembly is held securely in place.

(2) Thread wire and cable through loom and bracket extending from front battery box.

(3) Bring wire to position on throttle lever arm on carburetor, hold lever arm forward, and connect wire to binding post on arm.

103. CHOKE CONTROL.

a. **Description.** The choke knob is at the lower right in the control group on the left side of the instrument panel (fig. 7). This knob has a wire connection (fig. 72) to a valve in the carburetor that regulates the carburetor air supply. Pulling out the knob cuts down on the amount of air to the carburetor.

b. Removal.

(1) Loosen clamping screws holding choke wire to carburetor valve arm, and remove wire.

(2) Unscrew elastic stop nut from choke knob casing on back of instrument panel, and remove nut. Remove knob, casing, and wire from the front of the instrument panel.

c. Installation.

(1) Insert choke wire and casing through instrument panel hole until rim of knob casing holds against front of panel. Carry nut over wire at back of instrument panel, and tighten nut on threaded section of knob casing until the assembly is held securely in place.

GENERATING UNIT M18

(2) Thread wire and cable through loom and bracket attached to front battery box.

(3) Bring wire to carburetor, hold lever arm forward, and connect wire to binding post on choke lever arm.

104. T-SLOT RECEPTACLE.

a. Description. Four T-slot receptacles (figs. 7 and 72) of the regular base receptacle type, are provided on the instrument panel. They are intended for use with 125-volt trouble light carried in the tool box and for electric tools. These receptacles are made up of two dual units similar in design and construction to those used in home lighting circuits.

b. Removal.

(1) Unscrew connector screws at back of receptacle, and take off leads.

(2) Take out the two nuts, lock washers, and bolts holding the receptacles to the panel, and remove bracket and receptacle.

c. Installation.

(1) Position receptacle and bracket over hole from rear of instrument panel, aligning tapped mounting holes in bracket's ears with mounting holes in panel. Secure receptacle and bracket to panel with bolts, lock washers, and nuts provided for the purpose.

(2) Connect wires as follows:

(a) *Top Receptacle.* Connect two lead wires "12" to upper terminal, lead wire "2C" to lower terminal.

(b) *Bottom Receptacle.* Connect two lead wires "14" to upper terminal, lead wire "2A" to lower terminal.

105. TERMINAL BLOCKS.

a. Description. A 12-position terminal block (fig. 72) in back of the instrument panel handles connections for 125-volt circuit. A center label strip identifies the connections. The upper three positions are unused. The block is mounted on arms welded to the circuit breaker bracket. A similar, but smaller, 4-position terminal block (fig. 72), attached to the rear of the instrument panel, handles connections for the battery circuit.

b. Maintenance. Periodically, make a check on the cable connections at the terminal blocks. Check for clean and tight connections. Connections showing signs of corrosion must be removed and thoroughly scraped clean.

106. FUSE BLOCKS.

a. Description. Two fuse blocks are used. One is located on the side of the circuit breaker (fig. 72) on the rear of the instrument panel. It is a double-fuse type and is connected into the 125-volt light circuit. The other fuse block, a single-fuse type, is located on

PAINTING

the rear of the instrument panel adjacent to the small terminal block (fig. 72). It is connected into the battery circuit. All fuses are 25-ampere capacity.

b. **Maintenance.** Periodically, tighten all cable connections on fuse clips. Remove and clean all corroded cable connections.

Section XVII
PAINTING

	Paragraph
General	107
Preparing for painting	108
Painting metal surfaces	109
Paint as a camouflage	110
Removing paint	111
Painting lubricating devices	112

107. GENERAL.

a. Ordnance materiel is painted before it is issued to the using arms, and one maintenance coat per year will ordinarily be ample for protection. With but few exceptions, this materiel will be painted with ENAMEL, synthetic, olive-drab, lusterless. The enamel may be applied over old coats of long oil enamel and oil paint previously issued by the Ordnance Department, if the old coat is in satisfactory condition for repainting.

b. Paints and enamels are usually issued ready for use, and are applied by brush or spray. They may be brushed on satisfactorily when used unthinned in the original package consistency, or when thinned no more than 5 percent by volume with THINNER, for synthetic enamels. The enamel will spray satisfactorily when thinned with 15 percent by volume of THINNER, for synthetic enamels. (Linséed oil must not be used as a thinner, since it will impart a luster not desired in this enamel.) If sprayed, it dries hard enough for repainting within ½ hour, and dries hard in 16 hours.

c. Complete information on painting is contained in TM 9-850.

108. PREPARING FOR PAINTING.

a. If the base coat on the materiel is in poor condition, it is more desirable to strip the old paint from the surface with REMOVER, paint and varnish, than to use sanding and touch-up methods. After stripping, it will then be necessary to apply a primer coat.

b. PRIMER, synthetic, refinishing, should be used on wood as a base coat for synthetic enamel. It may be applied either by brushing or spraying. It will brush satisfactorily as received, or after the addi-

GENERATING UNIT M18

tion of not more than 5 percent by volume of **THINNER** paint, volatile mineral spirits. It will be dry enough to touch in 30 minutes, and hard in 5 to 7 hours. For spraying, it may be thinned with not more than 15 percent by volume of **THINNER**, paint, volatile mineral spirits. Lacquers must not be applied to the **PRIMER**, synthetic, refinishing, within less than 48 hours.

c. **PRIMER**, synthetic, rust-inhibiting, for bare metal, should be used on metal as a base coat. Its use and application are similar to that outlined in subparagraph b, above.

d. The success of a job of painting depends partly on the selection of a suitable paint, but also largely upon the care used in preparing the surface prior to painting. All parts to be painted should be free from rust, dirt, grease, kerosene, oil, and alkali, and must be dry.

109. PAINTING METAL SURFACES.

a. If metal parts are in need of cleaning, they should be washed in a liquid solution consisting of $\frac{1}{2}$ pound of **SODA ASH** in 8 quarts of warm water, then rinsed in clear water and wiped thoroughly dry. Wood parts in need of cleaning should be treated in the same manner, but the alkaline solution must not be left on for more than a few minutes, and the surfaces should be wiped dry as soon as they are washed clean. When equipment is in fair condition, and marred only in spots, the bad places should be touched up with **ENAMEL**, synthetic, olive-drab, lusterless, and permitted to dry. The whole surface will then be sandpapered with **PAPER**, flint, class B, No. 1, and a finish coat of **ENAMEL**, synthetic, olive-drab, lusterless, applied, and allowed to dry thoroughly before the material is used. If the equipment is in bad condition, all parts should be thoroughly sanded with **PAPER**, flint, class B, No. 2, or equivalent, given a coat of **PRIMER**, synthetic, refinishing, and permitted to dry for at least 16 hours. Then sandpaper with **PAPER**, flint, class B, No. 00, wipe free from dust and dirt, and apply a final coat of **ENAMEL**, synthetic, olive-drab, lusterless. Allow to dry thoroughly before the material is used.

110. PAINT AS A CAMOUFLAGE.

a. Camouflage is now a major consideration in painting ordnance equipment, with rust prevention secondary. The camouflage plan at present employed utilizes three factors: color, gloss, and stenciling.

(1) **COLOR**. The equipment is painted with **ENAMEL**, synthetic, olive-drab, lusterless, which was chosen to blend in reasonably well with the average landscape.

(2) **GLOSS**. The new lusterless enamel makes equipment difficult to see from the air or from relatively great distances over land. A unit painted with ordinary glossy paint can be detected more easily and at greater distances.

PAINING

(3) **STENCILING.** White stencil numbers have been eliminated because they can be photographed from the air. **ENAMEL**, synthetic, stenciling, lusterless, blue-drab, is now used, which cannot be so photographed. It is illegible to the eye at distances exceeding 75 ft.

b. Preserving Camouflage.

(1) Continued friction or rubbing must be avoided, as it will smooth the surface and produce a gloss. The unit should not be washed more than once a week. Care should be taken to see that the washing is done entirely with a sponge or a soft rag. The surface should never be rubbed or wiped, except while wet, or a gloss will develop.

(2) It is not desirable that equipment, painted with lusterless enamel, be kept as clean as equipment was kept when glossy paint was used. A small amount of dust increases the camouflage value. Grease spots should be removed with **SOLVENT**, dry-cleaning. Whatever portion of the spot cannot be so removed should be allowed to remain.

(3) Continued friction of wax-treated tarpaulins on the sides of a vehicle will also produce a gloss which should be removed with **SOLVENT**, dry-cleaning.

(4) Tests indicate that repainting with olive-drab enamel will be necessary once yearly, with blue-drab stenciling enamel twice yearly.

111. REMOVING PAINT.

a. After repeated paintings, the paint may become so thick as to crack and scale off in places, presenting an unsightly appearance. If such is the case, remove the old paint by use of a lime-and-lye solution (see TM 9-850 for details) or **REMOVER**, paint and varnish. It is important that every trace of lye or other paint remover be completely rinsed off, and that the equipment be perfectly dry before repainting is attempted. It is preferable that the use of lye solutions be limited to iron or steel parts. If used on wood, the lye solution must not be allowed to remain on the surface for more than a minute before being thoroughly rinsed off, and the surface wiped dry with rags. Crevices or cracks in wood should be filled with putty, and the wood sandpapered before refinishing.

112. PAINTING LUBRICATING DEVICES.

a. A circle about $\frac{3}{4}$ inch in diameter will be painted with **ENAMEL**, synthetic, gloss-red, around each point of lubrication, such as oil cups, grease fittings, oilholes, and similar lubricating devices, in order that they may be readily located. Do not paint openings in fittings through which lubricant passes.

GENERATING UNIT M18

Section XVIII

STORAGE AND SHIPMENT

	Paragraph
Preparation for domestic shipment	113
Loading materiel on railroad car	114
Limited storage instructions	115

113. PREPARATION FOR DOMESTIC SHIPMENT.

a. **General.** The Generating Unit M18 when mounted on Trailer Chassis M7 will be shipped uncrated for domestic shipment by rail (par. 114 b). All precautions should be taken to prevent corrosion during shipment.

b. Preparation.

(1) **LUBRICATION.** Lubricate the generating unit and trailer in accordance with the lubrications instructions in section IV.

(2) **FUEL.** Drain fuel from fuel tank.

(3) **BATTERY.**

(a) Disconnect battery lead terminals. Clean and tape the terminals, and secure away from the battery posts.

(b) Apply coating of COMPOUND, rust-preventive, light, to battery posts.

(c) Batteries shall be recharged before shipment if hydrometer readings fall below 1.275.

(4) **CLEANING.**

(a) The materiel shall be thoroughly cleaned and made free of all foreign matter by using SOLVENT, dry-cleaning, or a soap solution as follows:

1. Apply SOLVENT, dry-cleaning, by scrubbing with a clean brush or wiping with a clean saturated cloth.

2. Apply soap solution by vigorously brushing or scrubbing the surfaces thoroughly until all traces of contamination have been removed. Rinse the surfaces with clean hot water and dry thoroughly.

(b) Avoid contact of bare hands with the cleaned surfaces.

(5) **PAINTING.** Exterior painted surfaces that have become checked, pitted, or rusted must have the rust spots removed and the surfaces repainted.

(a) *Removing Rust Spots.* All exterior painted surfaces that have become checked, pitted, or rusted shall have the rust spots removed with the following:

1. **CLOTH**, abrasive, aluminum-oxide, for cleaning finished and unfinished external surfaces where wear of the parts cleaned will not affect the functioning of the mechanism.

2. **CLOTH**, crocus, for removing rust or stain and polishing parts of finished surfaces of metal.

(b) *Application of PRIMER, Synthetic, Rust-inhibiting.* Apply a

STORAGE AND SHIPMENT

liberal coating of PRIMER, synthetic, rust-inhibiting, over entire area of the cleaned surfaces to be repainted as follows:

1. *Brushing or Spraying.* PRIMER, synthetic, rust-inhibiting, should be used on bare metal as a base coat for synthetic enamel. It may be applied either by brushing or spraying. The primer will brush satisfactorily as received or after the addition of not more than 5 percent by volume of the proper thinner. For spraying, the primer may be thinned with not more than 15 percent by volume of THINNER. Allow to dry thoroughly.

(c) *Sandpapering Surfaces.* Sandpaper the primed surfaces with PAPER, flint, class B, No. 00, and wipe all particles of dust from surfaces.

(d) *Application of Enamel.* Apply coat of ENAMEL, synthetic, olive-drab, lusterless, and allow to dry thoroughly before the materiel is used.

(6) APPLICATION OF PRESERVATIVES. (Application of preservatives should be accomplished immediately after cleaning.)

(a) Exterior unpainted metal surfaces of the generating unit and trailer shall be treated with COMPOUND, rust-preventive, thin film, by spraying or brushing. NOTE: Rubber equipment must be kept free from petroleum oils and greases including rust-preventive compounds.

(7) ENGINE, COOLING SYSTEM AND ELECTRICAL SYSTEM. Refer to IOSSC-(j), Revision "Preparation of Unboxed Ordnance Materiel for Shipment," section II.

(8) INSPECTION. Make a systematic inspection just before shipment or storage, and list all missing or broken items that are not replaced or repaired, and attach list to unit.

114. LOADING MATERIEL ON RAILROAD CAR.

a. Instructions.

(1) INSPECTION. All railroad cars must be inspected to see that they are suitable to carry loads to destination. Floors must be sound, and all loose nails and other projections not an integral part of the car should be removed.

(2) RAMPS. Permanent ramps should be used for loading materiel when available, but when such ramps are not available, improvised ramps may be constructed of rail ties and other available lumber.

(3) HANDLING.

(a) Cars loaded in accordance with specifications given herein must not be handled in hump switching.

(b) Cars must not be cut off while in motion, and must be coupled carefully and all unnecessary shocks avoided.

(c) Cars must be placed in yards or on sidings so that they will be subjected to as little handling as possible. Separate track, or tracks,

GENERATING UNIT M18

when available, must be designated at terminals, classification or receiving yards, for such cars, and cars must be coupled at all times during such holding and hand brakes set.

(4) **PLACARDING.** Materiel not moving in combat service must be placarded, "DO NOT HUMP."

(5) **CLEARING LIMITS.** The height and width of load must be within the clearance limits of the railroads over which it is to be moved. Army and railroad officials must check on clearances prior to each move.

(6) **MAXIMUM LOAD WEIGHTS.** In determining the maximum weight of load, the following shall govern, except where load weight limit has been reduced by the car owner.

Marked Capacity of Car	Total Weight of Car and Load	Load Weight
40,000 lb.....	66,000 lb.....	66,000 lb less Lt. Wt. of Car
60,000 lb.....	103,000 lb.....	103,000 lb less Lt. Wt. of Car
80,000 lb.....	136,000 lb.....	136,000 lb less Lt. Wt. of Car
100,000 lb.....	169,000 lb.....	169,000 lb less Lt. Wt. of Car
140,000 lb.....	210,000 lb.....	210,000 lb less Lt. Wt. of Car
200,000 lb.....	251,000 lb.....	251,000 lb less Lt. Wt. of Car

Example

Capacity of car	100,000 lb
Total weight of car and load	169,000 lb
*Light weight of car (to be subtracted)	37,000 lb
permissible weight of load	132,000 lb

*This marking is stenciled on each side of car indicated as "LT. WT."

Load must be so placed on the car that there will not be more weight on one side of the car than on the other. One truck of the carrying car must not carry more than one-half of the load weight.

(7) **BRAKE WHEEL CLEARANCE (A, fig. 73).** Each railroad car must be loaded with a resulting brake wheel clearance of at least 6 inches in front, at each side and at the top. Brake wheel clearance should be increased as much as is consistent with proper location of load.

(8) **DISTRIBUTION OF LOAD.** Materiel should be centered as nearly as possible so that equal weight bears on each truck of the car. **NOTE:** When loading railroad cars, materiel shall be so loaded as to require a minimum number of cars. To accomplish this, various types of materiel can be loaded on the same car *provided all have the same destination.*

(9) **BRAKES.** After loading and bracing the materiel, set the hand brakes.

STORAGE AND SHIPMENT

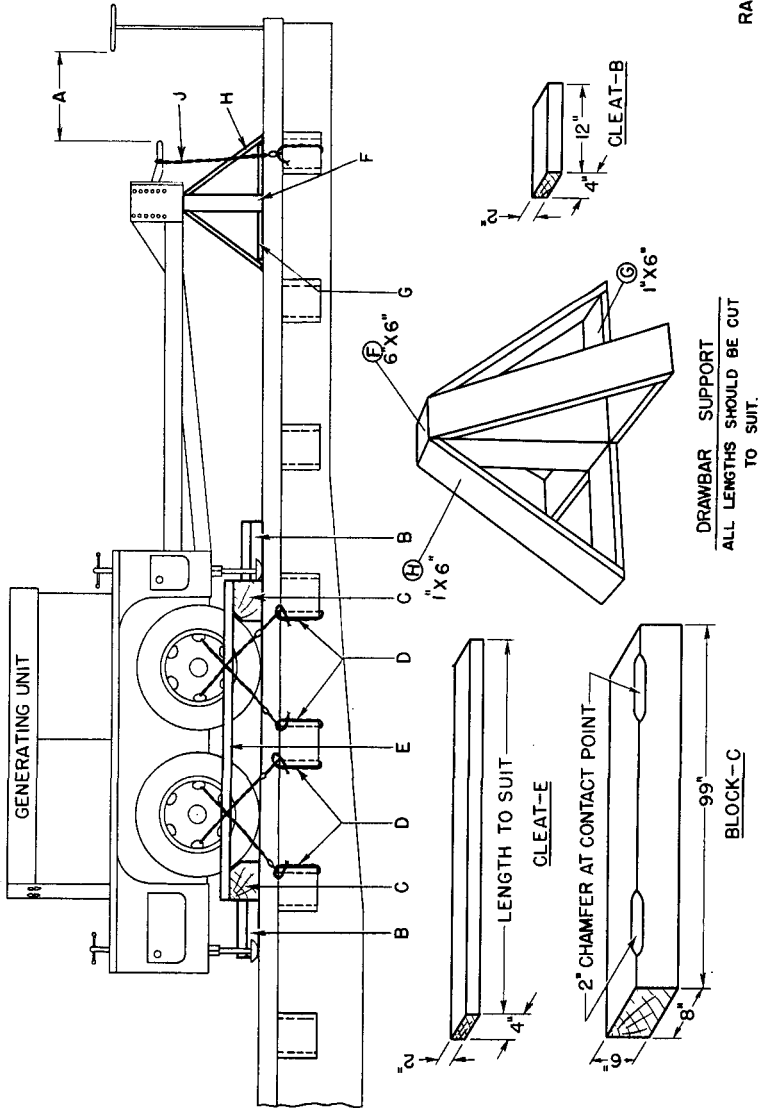

RA PD 80361

Figure 73 — Method of Blocking Generator Trailer M7 and Generating Unit M18 on Railroad Car

GENERATING UNIT M18

(10) **TIRES.** Inflate the tires to 10 pounds per square inch above the prescribed pressure.

(11) **TYPE OF CARS.** Shipments of materiel are made on flat cars, end-door box cars, or side door box cars.

b. Method of Blocking Trailer M7 and Generating Unit M18 on Railroad Car. All item reference letters given below refer to the details and locations in figure 73).

(1) **TRAILER WHEELS.**

(a) *Blocks C (2 Blocks C Required).* Place one block C across the front of the trailer tires, and one at the rear tires. These blocks will be at least 8 inches longer than the over-all width of the tires.

(b) *Cleats B (8 Cleats B Required).* Place two cleats B to the front of block C at each wheel. Nail the lower cleat to the car floor with three 40-penny nails, and nail the top cleat to the cleat below with three 40-penny nails.

(c) *Cleats E (2 Cleats E Required).* Place one cleat E against the outside face of each wheel on the top of block C. Nail cleats E to each block C with four 40-penny nails.

(d) *Strapping Trailer Wheels D.* Secure unit at each wheel by strapping, consisting of four strands, two wrappings of No. 8 gage, black annealed wire. Pass wire through opposite openings in wheels, and attach at the nearest stake pockets of the car. Tighten wire sufficiently to remove slack. **NOTE:** When box cars are used, strapping should be applied in similar fashion, and attached to car floor by use of blocking or anchor plates.

(e) Position trailer chassis support legs at the four corners of the unit.

(2) **DRAWBAR.**

(a) *Block F (One Block F Required).* Place one block F under tongue of unit in center, and toenail to car floor, using four 40-penny nails.

(b) *Cleats G (4 Cleats G Required).* Locate on floor against four sides of block F. Nail to floor, using four 20-penny nails in each cleat.

(c) *Braces H (4 Braces H Required).* Cut braces long enough to extend from floor to top of block F. Nail to block F, cleats G, and the car floor with three 20-penny nails in each end.

(d) *Strapping Drawbar J.* Secure drawbar at stake pocket on each side of car by looping wire, four strands, two wrappings of No. 8 gage, black annealed around lunette. Twist each wire taut with rod or bolt.

115. LIMITED STORAGE INSTRUCTIONS.

a. When trailer and unit are stored uncrated, preparation will be in accordance with paragraph 113 b.

b. **Periodical Inspections.** Periodical inspections shall be made while the materiel is stored, to note among other things, general con-

REFERENCES

dition, missing parts, and the need for repairs. If found to be corroding at any part, the entire procedure as given in paragraph 113 b will be repeated.

c. Repeat the battery service as described in paragraph 113 b (3). Do not attempt to charge battery by running the engine.

d. Inspect the tires, repair any leaks that have developed, and inflate, if necessary.

Section XIX
REFERENCES

	Paragraph
Publications indexes	116
Standard nomenclature lists	117
Explanatory publications	118

116. PUBLICATION INDEXES.

The following publications indexes should be consulted frequently for latest changes or revisions of references given in this section and for new publications relating to materiel covered in this manual:

- a. Ordnance Publications for Supply Index (index to SNL's) ASF Cat. **ORD-2 OPSI**
- b. Index to Ordnance Publications (listing FM's, TM's, TC's, and TB's of interest to ordnance personnel, FSMWO's, BSD, S of SR's, OSSC's, and OFSB's, and includes Alphabetical List of Major Items with Publications Pertaining Thereto) **OFSB 1-1**
- c. List of Publications for Training (listing MR's, MTP's, T/BA's, T/A's, FM's, TM's, and TR's concerning training) **FM 21-6**
- d. List of Training Films, Film Strips, and Film Bulletins (listing TF's, FS's, and FB's by serial number and subject) **FM 21-7**
- e. Military Training Aids (listing Graphic Training Aids, Models, Devices, and Displays) **FM 21-8**

117. STANDARD NOMENCLATURE LISTS.

- a. Trailer, generator, M7 **SNL F-226**
- b. Unit, generating, M18 **SNL F-291**

118. EXPLANATORY PUBLICATIONS.

- a. Automotive electricity **TM 10-580**
- b. Automotive lubrication **TM 10-540**

GENERATING UNIT M18

c. Camouflage	FM 5-20
d. Chassis, body and trailer units	TM 10-560
e. Chemical decontamination materials and equipment	TM 3-220
f. Cleaning, preserving, lubricating, and weld- ing materials and similar items issued by the Ordnance Department	TM 9-850
g. Cold weather lubrication and service of ar- tillery equipment	OFSB 6-5
h. Cold weather lubrication and service of com- bat and automotive equipment	OFSB 6-11
i. Defense against chemical attack	FM 21-40
j. Detailed lubrication instructions, ordnance materiel	OFSB 6-series
k. Fuels and carburetion	TM 10-550
l. Hand, measuring, and power tools	TM 10-590
m. Maintenance and care of pneumatic tires and rubber treads	TM 31-200
n. Motor transport	FM 25-10
o. Motor transport inspections	TM 10-545
p. Motor vehicles	AR 850-15
q. Ordnance storage and shipment chart—Group F	OSSC F
r. Storage of motor vehicle equipment	AR 850-18
s. The internal combustion engine	TM 10-570
t. Trailer, generator, M7	TM 9-881

GENERATING UNIT M18

D—Cont'd	Page No.	Page No.
Description—Cont'd		
fuel pump	74	removal and installation
fuel system	73	Extension cord receptacle, 6-volt
generating system	110-111	description
Distributor		installation
functioning	98	
lubrications	27	
maintenance	98-100	
protection under unusual		
conditions	34	
tune-up	54	
		F
		Fan
		description and maintenance ...
		installation
		removal
		Fan belt, removal
		Filter
		functioning
		removal and installation of
		element
		Field rheostat
		description
		operation
		removal and installation
		Fire extinguisher
		maintenance
		operation
		Flexible exhaust pipe
		description
		Frame
		description
		maintenance
		Frequency meter, removal and
		installation
		Fuel pump
		description and maintenance ...
		removal and installation
		Fuel system
		air cleaner
		carburetor
		description
		fuel pump
		gasoline tank
		governor
		operation in desert conditions ..
		throttle body
		trouble shooting
		weekly and monthly inspection ..
		Functioning
		battery-charging generator ..
		cooling system
		engine
		engine electrical system
		fuel system

INDEX

F—Cont'd	Page No.		Page No.
Fuctioning—Cont'd		fuse blocks	126-127
thermostat	64	ignition switch	122
Fuse blocks, description	126-127	instrument panel	116-117
G			
Gasoline truck		lamp-dimming rheostat	123-124
construction	73-74	oil pressure gage	117
maintenance	74	125-volt light receptacle	122-123
Generating system		125-volt light switch	123
A-C generator		running time meter	120
description	111-112	6-volt extension cord	
maintenance	112-114	receptacle	124-125
description and operation	110-111	6-volt light receptacle	124
30-ampere power receptacles	115	6-volt light switch	124
200-ampere power receptacles	115	T-slot receptacle	126
trouble shooting	45-46	temperature gage	117-120
Generating unit M18		terminal blocks	126
data	11	throttle control	125
operation and controls	11-20	voltmeter	121
Generator and starter, protection		L	
under unusual conditions	32	Light receptacle, 125-volt	
Governor		description	122
adjustment	79-81	installation	123
construction	79	removal	122-123
functioning	79	Light switch, 6-volt, description	
I			
Ignition coil		and installation	124
installation	98	Light switch, 125-volt, description	
maintenance	97	and installation	123
removal	97	Lighting system, trouble shooting	47
Ignition switch, removal and installation	122	Lubricating devices, painting	129
Ignition system		Lubrication of engine under unusual conditions	31-32
operation		Lubrication system, operation under desert conditions	38
flood conditions	38	M	
in humid atmosphere	37	Maintenance	
trouble shooting	44-45	battery-charging generator	93-95
Inspection		cold weather	30
after long operation	22-23	engine	53
after short operation	22	frame	49
during operation	22	fuel pump	74
prestarting	21-22	manifold	66
weekly and monthly	23-24	oil pump	87
Instrument panel and instruments		thermostat	64
ammeter	121	water pump	62
battery-charging ammeter	117	Manifold	
choke control	125-126	description	66
field rheostat	121-122	installation	67-68
frequency meter	120	maintenance	66
		removal	66-67
		Muffler, maintenance	70

GENERATING UNIT M18

O		Page No.	Page No.
Oil filters, lubrication	27	Receptacle, light, 6-volt, removal and installation	124
Oil pressure gage, removal and installation	117	Receptacle, T-slot, removal and installation	126
Oil pump, description and main- tenance	87	Reports and records of lubrication	27
Oilcan points	27	Rheostat, lamp-dimming installation	123-124
Operation		removal	123
generating system	110-111	Running time meter, removal and installation	120
under unusual conditions			
cold weather accessories	36-37		
cold weather maintenance	30		
deep water fording	38-40		
desert conditions	37-38		
engine lubrication	31-32		
extreme heat	37		
flood conditions	38		
gasoline for low temperatures	30-31		
general conditions	35		
protection of cooling system	32		
protection of electrical system	32-35		
starting and operation	35-36		
Operation and controls			
engine and generating controls	14-16		
general care and precautions	19-20		
operating the unit	18-19		
preparation for operation of generating unit	11-14		
starting the unit	16-18		
stopping the unit	19		
P			
Paint(-ing)			
as camouflage	128-129		
lubricating devices	129		
metal surfaces	128		
preparation for	127-128		
removal	129		
Power receptacles, 200- and 30- ampere	115		
Prestarting inspection	21-22		
R			
Radiator, description and main- tenance	60		
Railroad car, loading materiel on	131-134		

S

Slave battery terminals, removal and installation	107
Spark plugs	
description	101
maintenance	102
protection under unusual conditions	34
removal and installation	102
trouble shooting	101-102
Starter switch, removal and in- stallation	107
Starting motors	
maintenance	103
removal and installation	103-104
Starting system, trouble shooting	43-44
Storage and shipment	
limited storage instructions	134-135
loading materiel on railroad cars	131-134
preparation for domestic shipment	130-131
Strainer, description and main- tenance	87

T

Temperature gage	
description	117
removal and installation	120
Terminal blocks, description and maintenance	126
Thermostat, removal and installa- tion	64
Throttle, operation	14-15
Throttle body	
description	81-82
maintenance	82
removal and installation	82

INDEX

T—Cont'd		Page No.			Page No.
Throttle control, removal and installation		125	ignition system		44-45
Tools and equipment			lighting system		47
accessories		29	spark plugs		101-102
fire extinguisher		29-30	starting system		43-44
tools		28-29	V		
Trouble shooting			Voltmeter, removal and installation		121
A-C generating system		47-48	W		
batteries and generating system		45-46	Water pump		
cooling system		43	installation		63-64
engine		41-43	maintenance		62
engine lubrication system		47	removal		63
fuel system		46-47	repacking		62-63

TECHNICAL MANUAL
GENERATING UNIT M18

Changes }
 No. 1 }

WAR DEPARTMENT
 Washington 25, D. C., 9 December 1944

TM 9-617, 19 January 1944, is changed as follows:

7. OPERATING THE UNIT.

a. **Circuit Breaker** (Superseded). With the throttle out (engine idling) and the rheostat set for minimum voltage, throw the main power switch to the "ON" position. Slowly push the throttle all the way in and allow the generator to come up to speed.

b. **Voltage Control.** Ascertain that voltage * * * at 250 volts. The output voltage, as controlled by the voltage regulator, is predetermined by the setting of the regulator voltage control. It is possible * * * to the right.

* * * * *

11. PRESTARTING INSPECTION.

a. Check fuel supply, engine oil, water, or antifreeze solution in radiator, lubrication, and levels of battery electrolyte. Inspect glass sediment * * * water is present.

* * * * *

1. (Added.) Check tools and spare parts for completeness.

15. WEEKLY AND MONTHLY INSPECTIONS.

* * * * *

c.

* * * * *

(2) ENGINE.

* * * * *

(a) Check crankcase, block, * * * bolts are tight.

(b) Remove valve covers and examine valve rods, springs, and valve clearances. Renew cover gaskets if necessary.

(c) Run engine, and * * * or carbon knock.

(d) Check oil pressure. * * * loose engine bearings.

Section IV (Superseded)

LUBRICATION

	<i>Paragraph</i>
Introduction.....	16
Lubrication order.....	17
General lubrication instructions.....	18
Reports and records.....	18.1

16. INTRODUCTION. Lubrication is an essential part of preventive maintenance, determining to a great extent the serviceability of parts and assemblies.

17. LUBRICATION ORDER.

a. War Department Lubrication Order No. 155 (fig. 11) prescribes first and second echelon lubrication maintenance.

b. The lubrication fittings indicated on the order are illustrated in figures 11.1, 11.2, and 11.3, showing their location on the matériel. The fittings shown in the figures may be identified on the order by the key numbers around the border.

c. A Lubrication Order is placed on or is issued with each item of matériel and is to be carried with it at all times. In the event the matériel is received without an order, a replacement should be immediately requisitioned. (See FM 21-6.)

18. GENERAL LUBRICATION INSTRUCTIONS.

a. Lubricants are prescribed in the "Key" on the order in accordance with three temperature ranges, "above +32° F.," "from +32° F. to 0° F.," and "below 0° F." The time to change grades of lubricants is determined by maintaining a close check on operation of the matériel during the approach to prolonged periods when temperatures will be consistently in a higher or lower range. Because of the time element involved in preparing for operation at lower prevailing temperatures, a change to lubricants prescribed for the next lower range will be undertaken the moment operation becomes sluggish. Ordinarily, it will be necessary to change lubricants only when expected atmospheric temperatures will be consistently in the next higher or lower range.

b. Service intervals specified are based on continuous use of the matériel under normal operating conditions. Reduce these intervals under extreme conditions such as excessively high atmospheric temperatures, temperatures below 0° F., prolonged periods of traveling, continued operation in sand or dust, immersion in water, or exposure to moisture. Any one of these conditions may quickly destroy the protective qualities of the lubricant, and require more frequent servicing in order to prevent malfunctioning or damage to the matériel. Intervals may be extended when the matériel is not in actual operation.

c. Lubrication equipment.

(1) Clean lubricating equipment both before and after use. Operate lubricating guns carefully and in such manner as to insure proper distribution of the lubricant. If lubrication fitting valves stick and prevent the entrance of lubricant, remove the fitting and determine cause. Replace broken or damaged lubricators. If lubricator cannot be replaced immediately, cover hole with tape as a temporary expedient

to prevent the entrance of dirt. If oil lines become clogged, disassemble the line and remove the obstruction.

(2) Lubricating fittings, grease cups, oilers, oil holes, fill, level, and drain plugs are circled in red for ready identification.

(3) Wipe lubricators and surrounding surfaces clean before applying lubricant. Where relief valves are provided, apply new lubricant until the old lubricant is forced from the vent. Exceptions are specified in notes or on the Lubrication Order. Metal surfaces on which a film of lubricant must be maintained by manual application, will always be wiped clean before the film is renewed.

d. Cleaning.

(1) Unless otherwise specified, use dry-cleaning solvent or Diesel fuel oil to clean or wash all metal parts, whenever partial or total disassembly is undertaken, or when renewing the protective lubricant film on exposed metal surfaces. Use of gasoline for cleaning is prohibited. Flushing of gear cases and housing will not be performed by the using arm.

(2) Care must be taken when cleaning oil and grease compartments to insure the complete removal of all residue or sediment. Dirt or other foreign matter should not be allowed to drop into the lubricant reservoirs.

e. **Supplementary instructions.** The following instructions supplement those notes on the Lubrication Order which pertain to lubrication and service of individual units and parts:

(1) **ENGINE AND CRANKCASE BREATHER AIR CLEANERS.** Perform servicing instructions as prescribed by the Lubrication Order. Intervals are based on continuous operation.

(2) **CRANKCASE.** Perform lubrication servicing instructions as prescribed by the Lubrication Order. Intervals are based on continuous operation. Drain only when engine is hot. After thoroughly draining, replace drain plug and refill crankcase to "FULL" mark on gauge, as prescribed by the Lubrication Order. Run engine a few minutes, recheck level, and add oil if required. Be sure pressure gauge indicates oil is circulating.

(3) **DISTRIBUTOR AND DISTRIBUTOR SHAFT.** Lubricate distributor as prescribed by the Lubrication Order. Intervals are based on continuous operation.

(4) **OIL FILTER.** Remove drain plug to drain sediment. After draining, remove check valve cap at top and blow out additional sediment with air hose. The filter will be disassembled, all parts washed and sludge scraped from filter felts, as prescribed by the Lubrication Order. Intervals are based on continuous operation. **Caution:** Do not remove felts from center tube. After reassembly, refill crankcase to "FULL" mark on gauge.

GENERATING UNIT M18

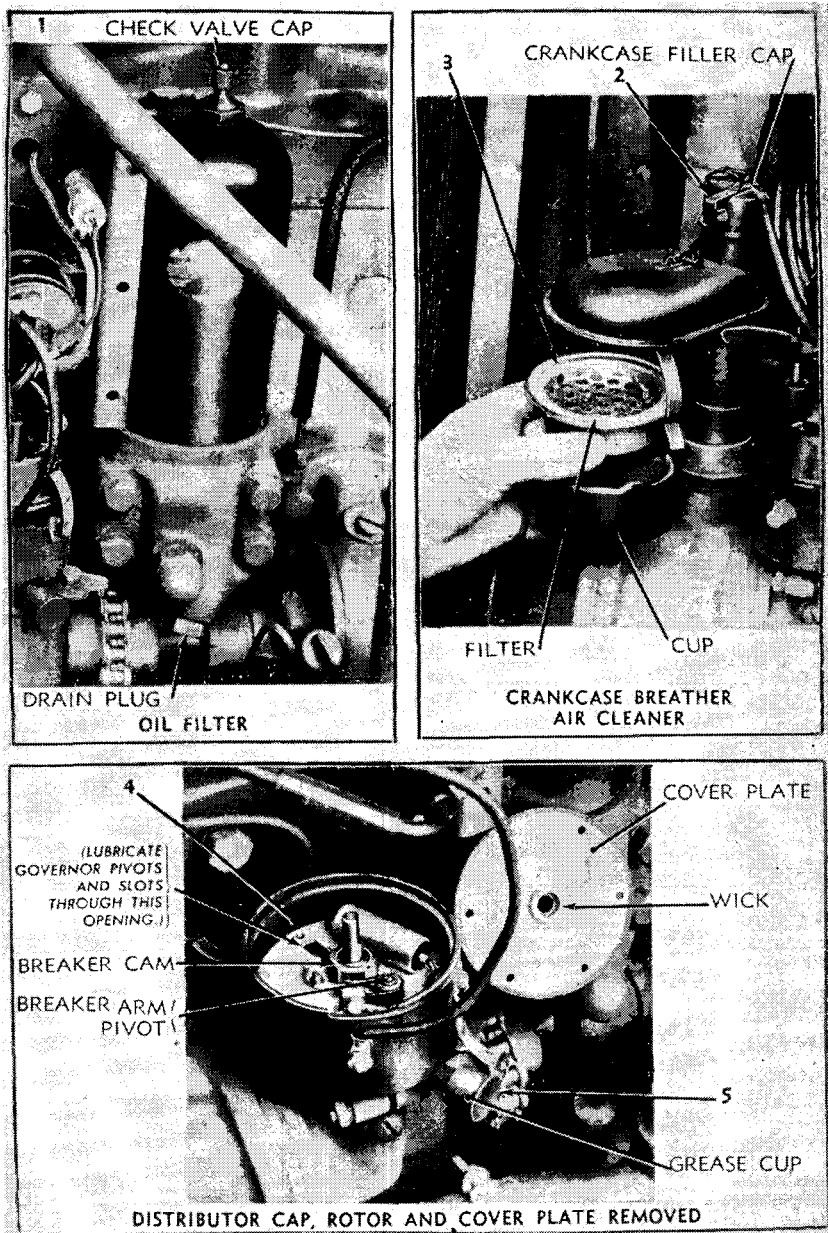

RA PD 31823

Figure 11.1.—Lubrication Points.

GENERATING UNIT M18

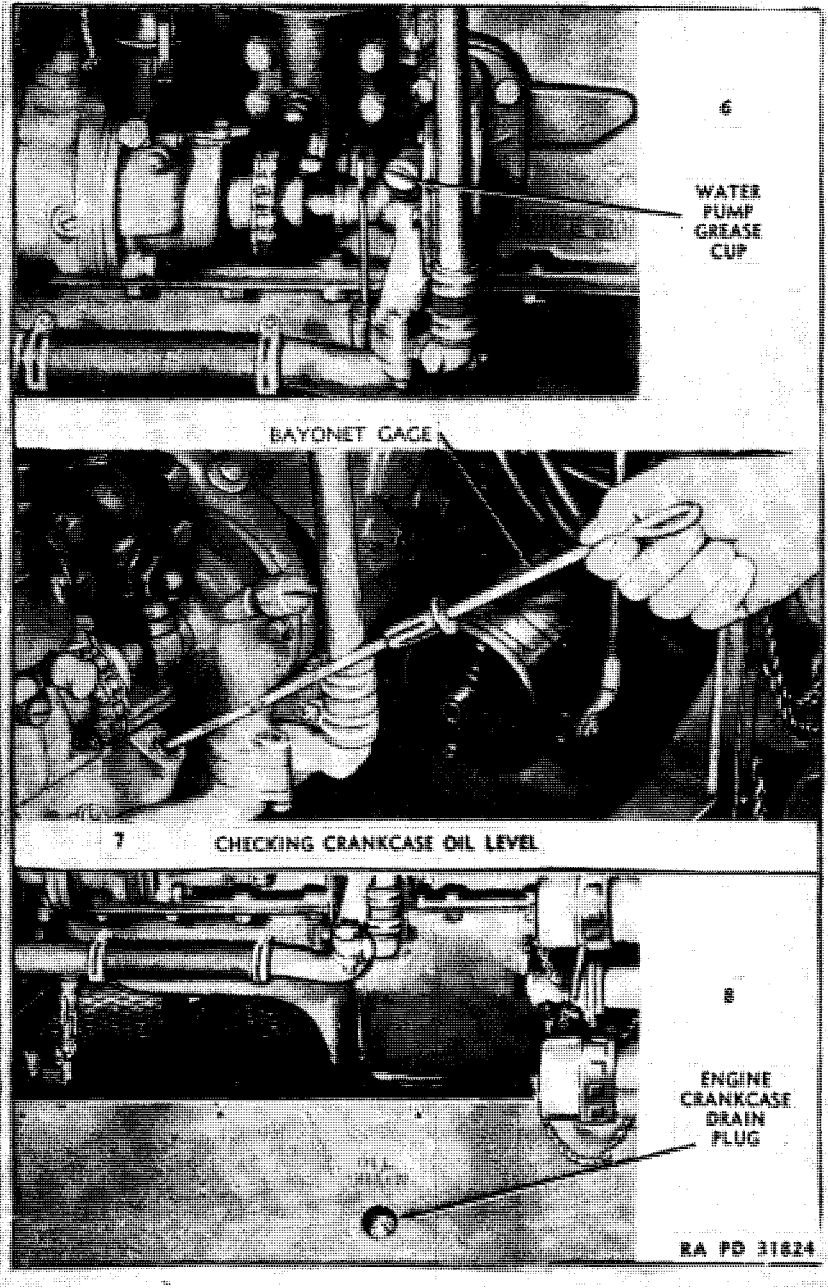

Figure 11.2.—Lubrication Points.

GENERATING UNIT M18

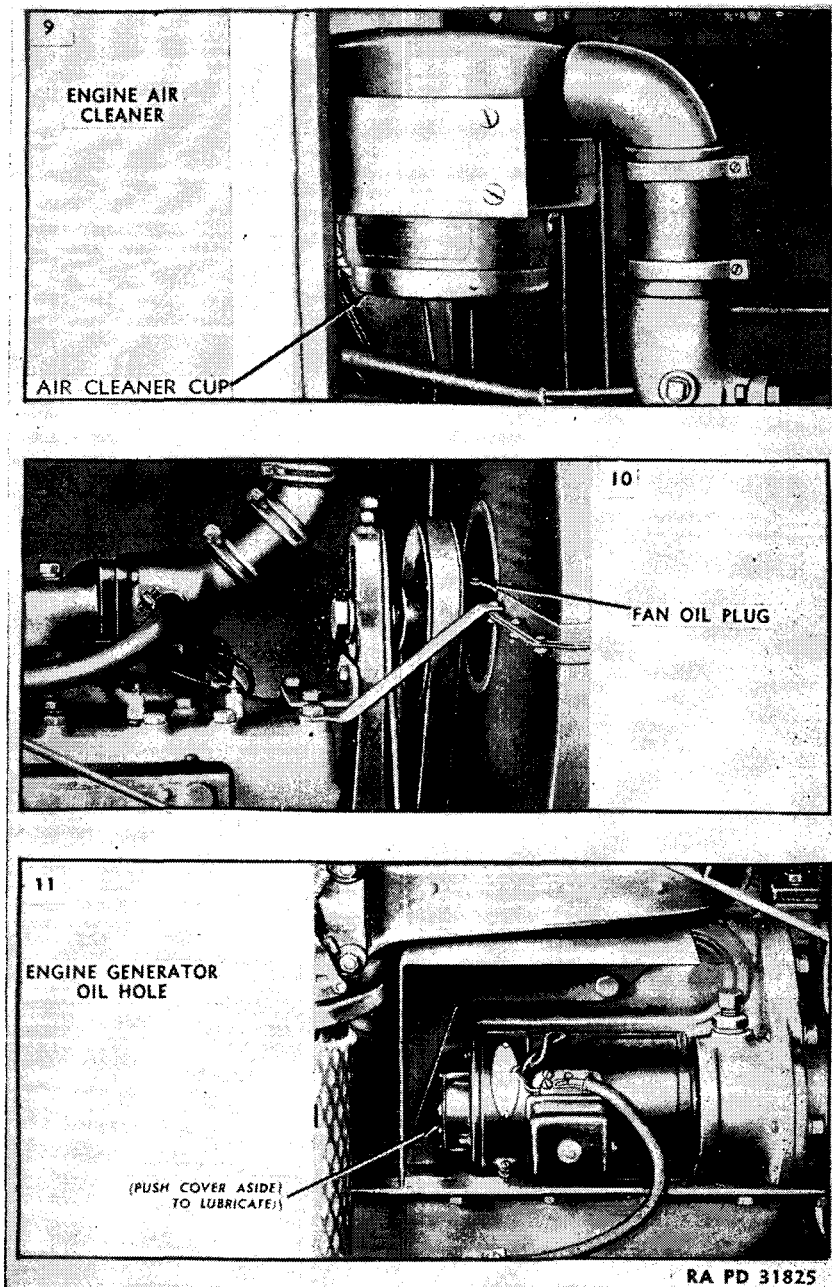

Figure 11.3.—Lubrication Points.

(5) Do NOT LUBRICATE: (Generating Unit M18) Governor flexible coupling, starters, and main generator.

18.1. REPORTS AND RECORDS. Report unsatisfactory performance of matériel to the Ordnance Officer responsible for maintenance in accordance with TM 38-250.

22. FIRE EXTINGUISHER.

a. **Location.** The fire extinguisher is located to the right of the instrument panel (fig. 12).

* * * * *

c. **Refilling.** Remove hexagonal filler cap, and fill to within $\frac{3}{4}$ inch of top with **fire extinguishing liquid**. Replace cap.

* * * * *

23. (Superseded). SUBZERO TEMPERATURES. Operation and maintenance of the unit at **subzero** temperatures involve factors not found at normal operating temperatures, and operators must devote more time to protective maintenance. Failure to provide * * * failure to start.

25. ENGINE LUBRICATION.

* * * * *

b.

* * * * *

(5) The following procedure * * * for cold starting:

(a) (Superseded.) Engine oil SAE 10 will be used. With oil level at "FULL" mark on gauge stick, add $1\frac{1}{2}$ quarts of motor fuel for each 5 quarts of crankcase capacity. For example, add $1\frac{1}{4}$ quarts of motor fuel for a 4-quart crankcase capacity; or 2 quarts for a 7-quart crankcase capacity.

* * * * *

(6)

* * * * *

(c) (Added.) Start engine again and run 5 to 10 minutes to mix oil and diluent thoroughly, then stop engine. Crankcase oil is then properly diluted to provide the necessary oil fluidity for the next cold start.

27. PROTECTION OF ELECTRICAL SYSTEM.

* * * * *

f. **Timing.** Check carefully. Take care that * * * advanced or retarded. **Instructions for ignition timing may be found in paragraph 49a(9).**

g. Batteries.

* * * * *

(2) While fully charged batteries will not freeze at subzero temperatures, fully discharged batteries will freeze and rupture at approximately +5° F. See that the * * * and 1.300 (fig. 48). If hydrometer is not available, have battery electrician check condition, using ammeter and voltmeter to determine battery condition.

* * * * *

(3) Maintain electrolyte level * * * tight and clean. At regular intervals, apply a coating of general purpose grease No. 0, to terminal connections after the cable clamps are in place on terminals.

* * * * *

28. GENERAL CONDITIONS.

* * * * *

f. Rescinded.

* * * * *

36. ENGINE.

* * * * *

e. Excessive Oil Consumption.

(1) *Oil Viscosity Too Low.* Drain and refill with the prescribed oil (par. 17e(2)).

* * * * *

37. COOLING SYSTEM.

a. Engine Overheats.

* * * * *

(6) (Added.) Either an overadvanced or retarded ignition setting will cause overheating. See paragraph 49a(9) for corrective action.

38. STARTING SYSTEM.

* * * * *

c. Slow Cranking Speed.

(1) **HIGH ELECTRICAL Resistance.** Visually inspect starting * * * (subpar. a(4), above).

* * * * *

49. TUNE-UP.

a. Procedure.

* * * * *

(2) **COMPRESSION.**

(a) Before making any * * * the valve mechanism. The compression of the engine should be checked first when tuning because an engine with uneven compression cannot be **tuned** successfully.

* * * * *

50. DESCRIPTION (fig. 16).

* * * * *

b. Functioning. The pump circulates * * * is warmed up. The water is also circulated in the jacket around the throttle body below the carburetor, to maintain the proper temperature of the fuel mixture.

51. CLEANING.

* * * * *

b. Cleaning.

* * * * *

(2) Allow the engine to cool **below 200° F.** Close drain valve, start the engine at idling speed, and start immediately to pour water slowly into the radiator, until it is **approximately half full.** **Start the engine and run at idling speed while adding cleaning compound** (Federal Stock No. 51-C-1568-500), in the proportion of one container of cleaner to every four gallons of cooling system capacity. Then fill the * * * into the system.

* * * * *

(4) Replace the radiator cap and run the engine at **fast idle**, covering the radiator if necessary, until the coolant reaches a temperature above 180° F. but not over 200° F. Do not allow * * * with the circulation.

* * * * *

c. Neutralizing.

(1) Allow the engine to cool **below 200° F.** Close drain valve and pour water slowly into radiator until it is **approximately half full.** **Start engine and run at idling speed while adding** the neutralizer compound (Federal Stock No. 15-C-1568-500) in the proportion of one container of neutralizer to every 4 gallons of cooling system capacity. Then fill the system with water.

* * * * *

d. Flushing.

(1) (Superseded.) Allow the engine to cool to below 200° F. Close drain valve and slowly pour water into the radiator until ap-

proximately half full. Start the engine and run at idling speed while adding water to the system until full.

* * * * *

f. Coolant Service.

* * * * *

(2) When servicing for * * * of clean water. Add sufficient **antifreeze compound** for protection against the lowest temperature likely to be encountered. Nearly fill the system with water, run the engine until normal operating temperature is reached; then add sufficient water to fill the system to proper height. (See part. 4c.)

66. AIR CLEANER.

* * * * *

c. Maintenance. Inspect the air cleaner by removing cup, to determine if steel-wire elements, deflector, and oil in cup are dirty (fig. 40). To remove air * * * from cleaner body. See section IV for maintenance procedure.

* * * * *

68. THROTTLE BODY.

* * * * *

c. Removal (fig. 42).

* * * * *

(5) Take out two cap screws and lock washers which hold the throttle body to the manifold and lift throttle body from the manifold.

* * * * *

69. DESCRIPTION (fig. 44).

a. The engine oil * * * from the camshaft. From the oil sump at the bottom of the crankcase, the pump draws oil through a strainer screen (fig. 44) and forces it **through the oil filter** to the main oil gallery, drilled in the cylinder block on the side opposite the camshaft. From here the * * * connecting rod bearings.

b. A certain amount of oil forced to the gallery is taken off through a bypass (fig. 44) **before going through the filter**, and sent back to the sump. A pressure regulating * * * of higher authority.

* * * * *

74. BATTERIES (fig. 48).

* * * * *

b. Maintenance (fig. 48).

* * * * *

(3) Cables and terminals * * * water and soap. After connecting cables to battery terminals, coat terminals with general purpose grease No. 1 above +32° F., or No. 0 below +32° F.

* * * * *

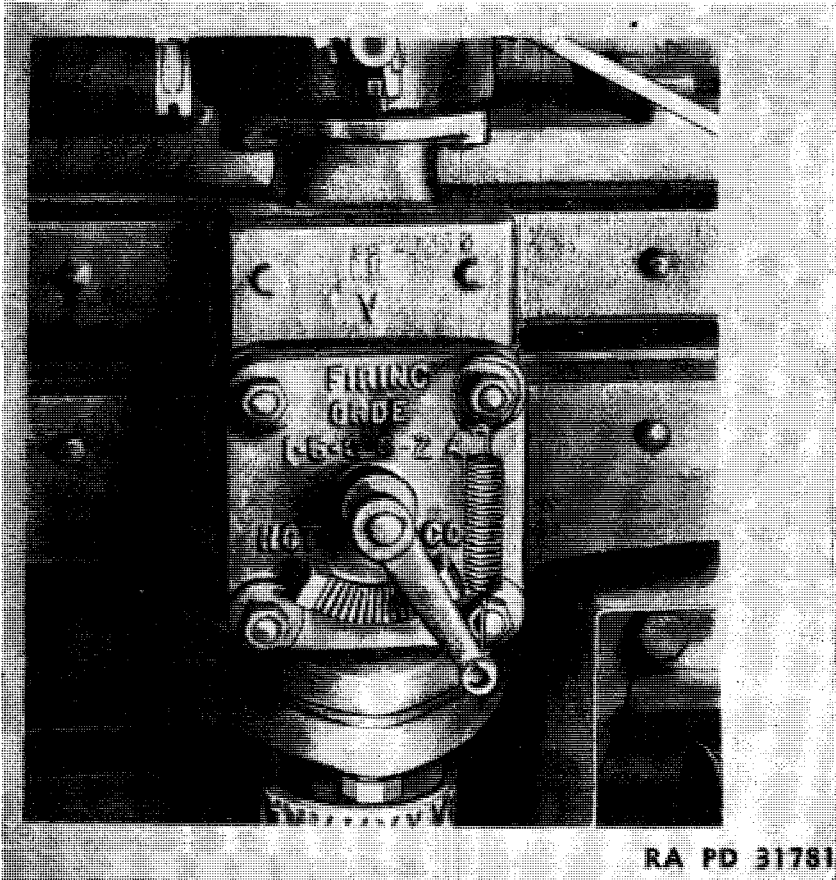

RA PD 31781

Figure 26.—Manifold Lever and Holding Spring.

77. DISTRIBUTOR (fig. 56).

a. Construction. The distributor is a 6-cylinder, automatic, single breaker arm type which contains the battery circuit breaker points, automatic advance mechanism, and high-tension rotor. A condenser is * * * the distributor body.

* * * * *

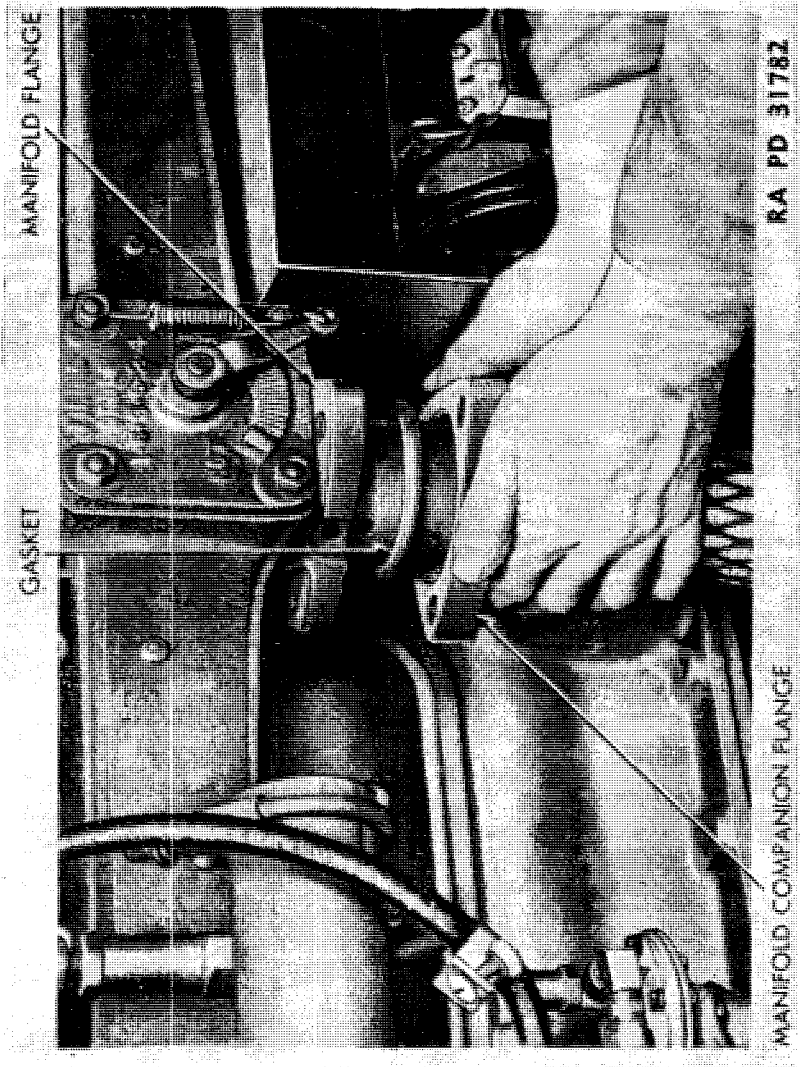

Figure 28.—Manifold Flange Gasket Installation.

79. STARTING MOTORS.

* * * * *

g. Bendix Spring Installation (fig. 64).

(1) Thoroughly clean Bendix * * * armature shaft bearings.
Do not apply oil to Bendix drive itself.

* * * * *

80. DESCRIPTION AND OPERATION (fig. 66).

a. The generating system * * * in one housing. The exciter field rheostat is a conventional **resistance-wire**, circular-type unit. It is connected * * * instrument panel lights.

* * * * *

81. A-C GENERATOR DESCRIPTION.

a. **Construction** (figs. 68 and 69). This generator consists * * * to provide cooling. This M3 Generator is a 3-phase **30 kw 80 percent power factor**, alternating-current, 60-cycle type. At 1,200 rpm, * * * when absolutely necessary.

* * * * *

94. FIELD RHEOSTAT.

* * * * *

c. **Installation.**

* * * * *

(3) Attach lead marked * * * and lock washer. Attach lead marked "**R4**" to center post of rheostat, and install a wire jumper from center post to front post. Secure with nuts and lock washers.

* * * * *

97. 125-VOLT LIGHT SWITCH.

* * * * *

c. **Installation.**

* * * * *

(2) Remove screw connectors. * * * "**14**" (from fuse). To the top rear connection, bring lead marked "**12**" (from fuse). The lower front * * * leads with screws.

* * * * *

108. PREPARING FOR PAINTING.

* * * * *

b. **PRIMER**, synthetic, refinishing, * * * for synthetic enamel. It may be applied either by brushing or spraying. It will brush satisfactorily as received, or after the addition of not more than 5 percent by volume of **THINNER, synthetic enamel**. It will dry enough to touch in 30 minutes, and hard in 5 to 7 hours. For spraying, it * * * than 48 hours.

* * * * *

113. PREPARATION FOR DOMESTIC SHIPMENT.

* * * * *

b. Preparation.

* * * * *

(2) (Superseded.) ENGINE.

(a) Drain oil, fuel lines, and fuel tanks.

(b) Add to fuel tanks several gallons of unleaded and undyed Treated gasoline.*

(c) Refill lubricating system, with preservative engine oil, grade 1, SAE 10. Tag No. 1 (fig. 72.1) shall be attached to filler cap of engines treated with preservative engine oil.

(d) Start engine, gradually bring speed up to 1,200 revolutions per minute, and allow to run at that speed for approximately 10 minutes in addition to the time required to use up all leaded gasoline in the lines and fuel system.

(e) Stop engine, remove spark plugs, and spray into tops of cylinders with preservative engine oil grade 2, SAE 30, while slowly rotating engine. Replace spark plugs.

(f) If spark plugs cannot be removed, spray preservative oil into air intake with engine running at a fast idle until smoke comes from exhaust pipe. **Caution:** Preservative oil should never be poured into the air intake.

1. After spraying preservative oil into air intake, using small, hand oiler, Federal Stock No. 13-0-400,** shut off engine and allow to cool for about 15 minutes.
2. Start engine and again spray preservative oil into air intake for several minutes only. The second spraying is necessary in order to coat exhaust valves.
3. Do not run engine more than several minutes as exhaust valves will become too hot for preservative oil to adhere properly. This treatment should be performed at such a time as to necessitate no further running of the motor before shipment.

(g) If it becomes necessary to run the engine after treatment, it should not be operated at over 1,200 revolutions per minute. Operation should be held to a minimum, and cylinders should be sprayed again after operation.

*If matériel is being moved with troops to ports of embarkation the regularly used gasoline need not be drained. Gum-preventive compound, however, will be added in the proportion of 4 ounces to 30 gallons of fuel.

**See ORD 6 SNL G-27, Second Echelon Tool Set No. 1.

(h) If matériel is shipped with troops, the fuel shut-off cock should be securely closed and the fuel tanks three-quarters filled with treated gasoline of type prescribed for the particular engine.

(i) If matériel is not shipped with troops, gasoline tanks and all parts of the fuel system shall be drained, because of the fire hazard, and the fuel tank cap securely replaced and the shut-off cocks closed. Parts of the fuel system to be drained are as follows:

- Fuel pump*
- Valves
- Screens

ATTACH TO FILLER
CAP OF ENGINES

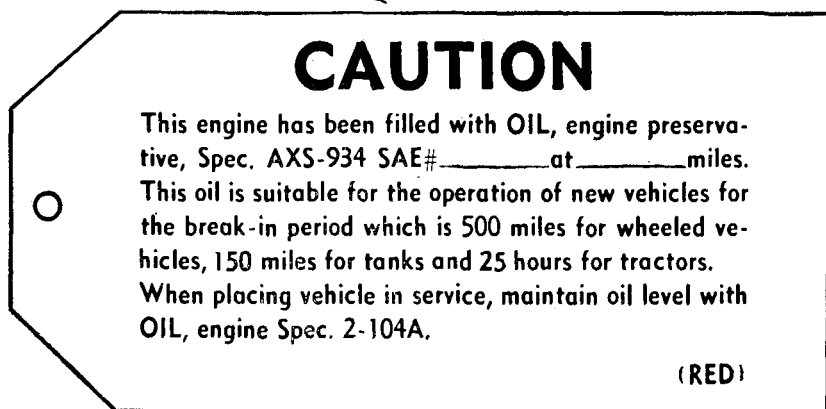

RA PD 80355

Figure 72.1—Caution Tag No. 1.

Carburetor

- Accelerator pump plunger
- Venturi of carburetor throat
- Choke and throttle valves
- Float mechanism

Fuel lines, fuel tanks, and screens

(3) (Superseded.) Care of generator and instrument panel. Completely cover the generator and the instrument panel with a heavy waterproof paper. Paper should be held in place with waterproof tape applied at intervals along the edges. Care should be taken not to seal the bottom of the paper shroud.

(4) CLEANING.

* * * * *

(c) (Added.) The exposed steel shafts of motors and generators shall be solvent-cleaned and coated with thin film rust-preventive compound. Special care shall be taken to keep this type of corrosion preventive out of bearings, off commutators, brushes, brush holders, collector rings, etc.

* * * * *

118. EXPLANATORY PUBLICATION.

* * * * *

h. Rescinded.

* * * * *

j. (Superseded.) War Department Lubrication Order (Guide)
----- No. 155

* * * * *

[AG 300.7 (8 Sep 44)]

BY ORDER OF THE SECRETARY OF WAR:

OFFICIAL:

J. A. ULIO

Major General

The Adjutant General

G. C. MARSHALL

Chief of Staff

DISTRIBUTION:

AAF (10); AGF (10); ASF (10); Dept (10); Arm & Sv Bd (2);
Tech Sv (2); SvC (10); PC&S (2) except OS (1); Gen & Sp
Sv Sch (10); USMA (2); ROTC (1); ROTC Lib (1); A (10);
CHQ (10); D (2) except 44 (3); B 44 (3); R 9 (4), 44 (3);
Sep Bn 9 (4), 44 (3); Bn 9 (2), 44 (3); C 9 (5); AF (2);
T/O & E 44-17 (2); 44-117 (2)

For explanation of symbols, see FM 21-6.